


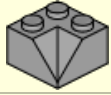
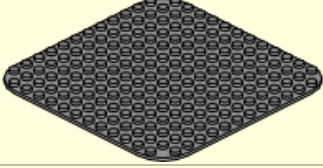
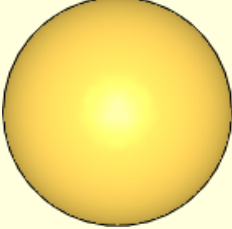
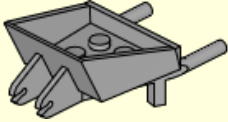
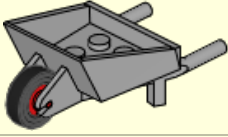




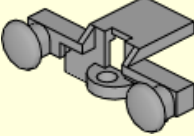



image	file	description
	4.dat	~Moved to 3193
	40.dat	~Moved to 3046
	400.dat	Baseplate 14 x 14 with Rounded Corners
	40000.dat	_Ball 52mm Diameter Yellow
	4003.dat	Wheelbarrow with 1 Wheel
	4003c01.dat	Wheelbarrow with 1 Wheel (Complete)
	4006.dat	Minifig Tool Spanner/Screwdriver
	401.dat	~Moved to 2516
	4019.dat	Technic Gear 16 Tooth
	401926.dat	_Technic Gear 16 Tooth Black
	4022.dat	Train Buffer Beam
	4023.dat	Train Coupling Type 1
	40232.dat	Animal Owl
	40234.dat	Animal Rat



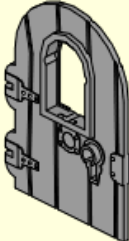
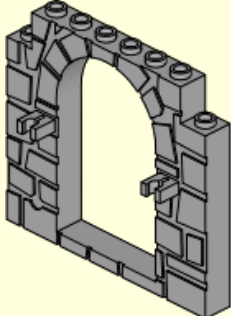
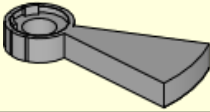
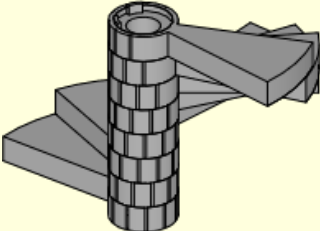

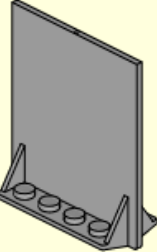

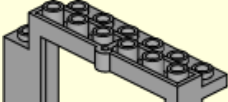
image	file	description
	40235.dat	Minifig Headdress Turban
	40239.dat	Minifig Hair Long Straight
	40241.dat	Door 1 x 4 x 6 with Window
	40242.dat	Door 1 x 8 x 6 Frame
	40243.dat	Staircase Spiral Riser
	40243c01.dat	Staircase Spiral (Complete 8 Steps)
	40244.dat	Staircase Spiral Axle
	40249.dat	Door 2 x 8 x 6 Revolving with Shelf Supports
	40251.dat	Minifig Hair Long Wavy
	40253.dat	Door 2 x 8 x 6 Revolving Frame

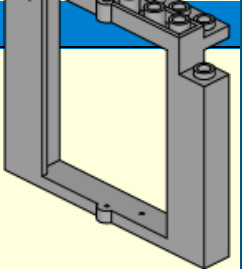



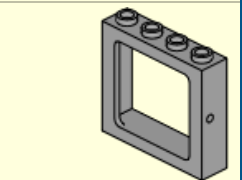
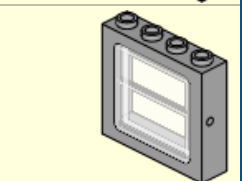
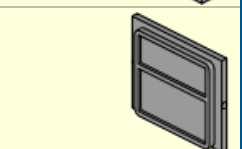
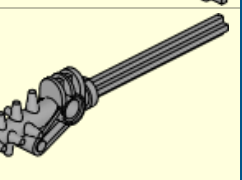
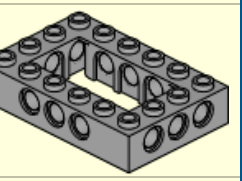
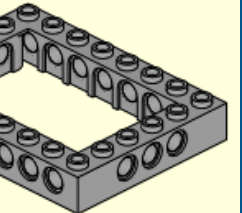
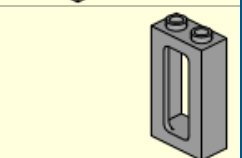

image	file	description
		without Bottom Notches
	4032.dat	~Moved to 4032a
	4032a.dat	Plate 2 x 2 Round with Axlehole Type 1
	4032b.dat	Plate 2 x 2 Round with Axlehole Type 2
	4033.dat	Train Window 1 x 4 x 3
	4033c01.dat	Train Window 1 x 4 x 3 with Trans-Clear Glass
	4034.dat	Glass for Train Window 1 x 4 x 3
	40340.dat	Technic Bionicle Weapon Drill with Axle
	40344.dat	Technic Brick 4 x 6 with Open Center 2 x 4
	40345.dat	Technic Brick 6 x 8 with Open Center 4 x 6
	4035.dat	Train Window 1 x 2 x 3
	4035c01.dat	Train Window 1 x 2 x 3 with Trans-Clear Glass














image	file	description
		
	4036.dat	Glass for Train Window 1 x 2 x 3
	40375.dat	Animal Dinosaur Body Neck/Tail Ring
	40376.dat	~Animal Dinosaur Tail/Neck Curved - Top (Needs Work)
	40377.dat	~Animal Dinosaur Tail/Neck Curved - Bottom (Needs Work)
	40378.dat	Animal Tail Section Middle with Pin
	40379.dat	Animal Tail Section End
	40380.dat	~Animal Dinosaur Legs Short, Left (Needs Work)
	40381.dat	~Animal Dinosaur Legs Short, Right (Needs Work)
	40386.dat	Animal Dinosaur Flipper with Pin
	40391.dat	~Animal Dinosaur Tail/Neck S Curve - Bottom (Needs Work)
	40392.dat	~Animal Dinosaur Tail/Neck S Curve - top (Needs Work)
	40394.dat	~Animal Dinosaur Tail Pin

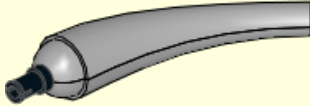

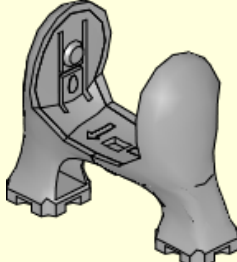

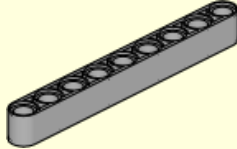


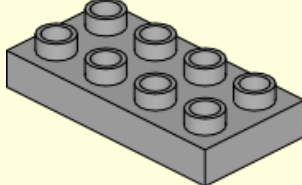
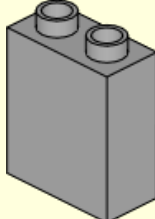
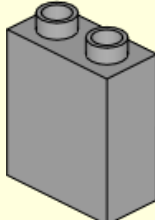

image	file	description
	40395.dat	Animal Dinosaur Tail/Neck Curved with Black Pin
	40396.dat	Animal Dinosaur Tail/Neck S Curve with Black Pin
	40397.dat	Animal Dinosaur Legs Short (Complete)
	404.dat	~Moved to 6541
	40490.dat	Technic Beam 9
	405.dat	~Moved to 44676
	40620.dat	Exhaust Pipe with Pin
	40666.dat	Duplo Plate 2 x 4
	4066a.dat	Duplo Brick 1 x 2 x 2 Type 1
	4066b.dat	Duplo Brick 1 x 2 x 2 Type 2
	4066bp01.dat	Duplo Brick 1 x 2 x 2 with Stop Sign





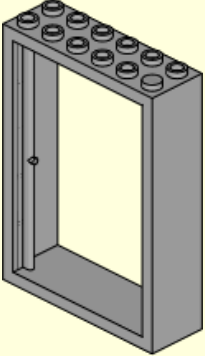
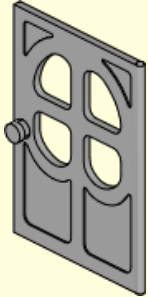




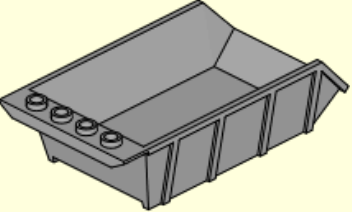


image	file	description
		Pattern
	407.dat	~Moved to 71076
	4070.dat	Brick 1 x 1 with Headlight
	407026.dat	_Brick 1 x 1 with Headlight Black
	4071.dat	Door 2 x 6 x 7 Frame
	4072.dat	Door 2 x 6 x 7 with Four Panes
	4073.dat	Plate 1 x 1 Round
	4079.dat	Minifig Seat 2 x 2
	407924.dat	_Minifig Seat 2 x 2 Yellow
	408.dat	~Moved to 71075
	4080.dat	Tipper Bucket 4 x 6
	4081.dat	~Moved to 4081b
	408126.dat	_Plate 1 x 1 with Clip Light Type 2



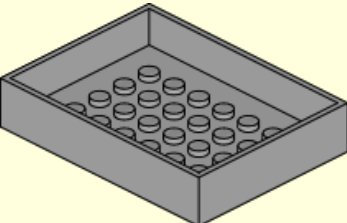
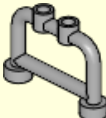







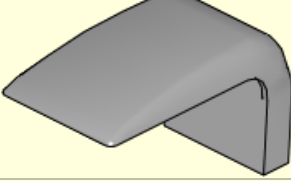
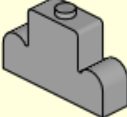
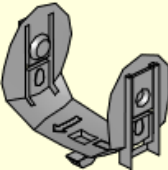

image	file	description
		Black
	4081a.dat	Plate 1 x 1 with Clip Light Type 1
	4081b.dat	Plate 1 x 1 with Clip Light Type 2
	4082.dat	Container Box 6 x 8 x 1 & 1/3
	4083.dat	Bar 1 x 4 x 2 with Studs
	4084.dat	Tyre 8/ 75 x 8 Offset Tread
	4085.dat	~Moved to 4085c
	408523.dat	_Plate 1 x 1 with Clip Vertical Type 3 Blue
	408526.dat	_Plate 1 x 1 with Clip Vertical - Type 3 Black
	4085a.dat	Plate 1 x 1 with Clip Vertical Type 1
	4085b.dat	Plate 1 x 1 with Clip Vertical Type 2
	4085c.dat	Plate 1 x 1 with Clip Vertical Type 3
	4086.dat	Vehicle Roof 4 x 7.5 x 3.667
	4088.dat	Brick 1 x 4 x 2 with Centre Stud Top
	40882.dat	~Animal Dinosaur Legs Short, Center (Needs Work)
	4089.dat	Slope Brick 33 3 x 2 Inverted Hollow with Towball

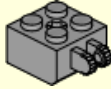

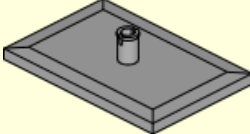
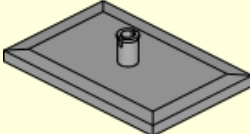
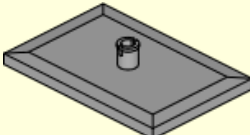
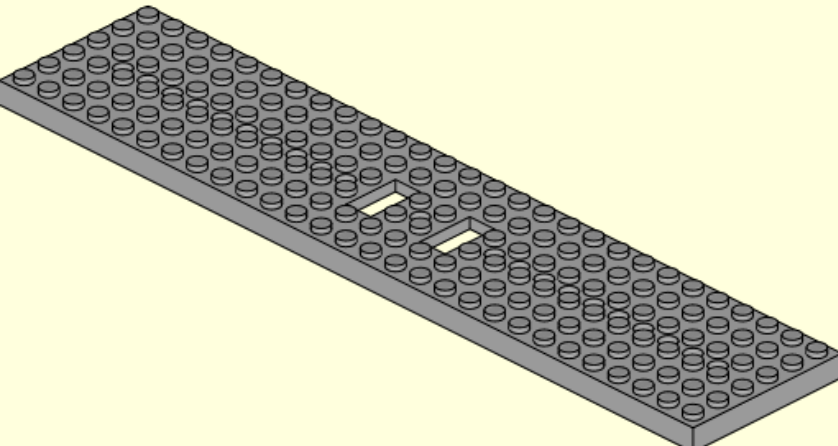
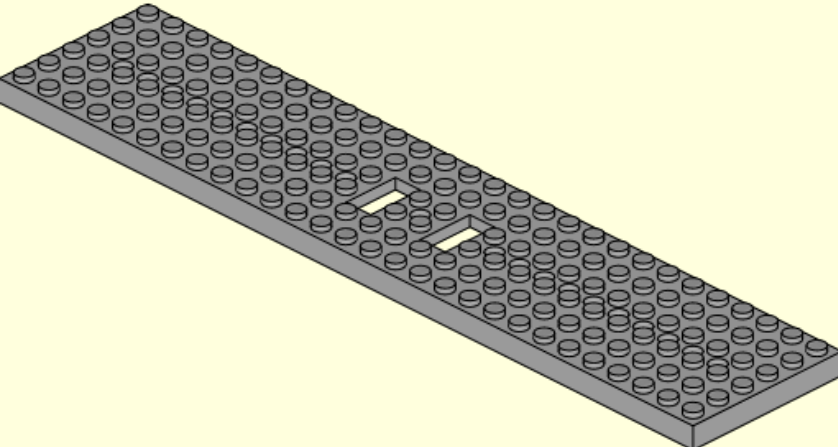
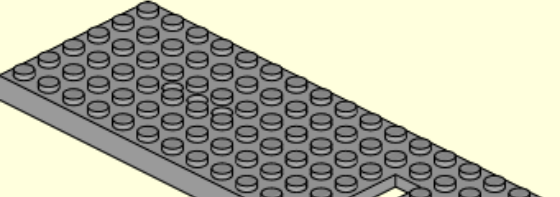
image	file	description
	40902.dat	Hinge Brick 2 x 2 Locking with Axlehole and Dual Finger
	4091.dat	~Wheel Fabuland Wheelbarrow
	4092.dat	~Moved to 4092a
	4092a.dat	Train Bogie Plate with Long Pin
	4092b.dat	Train Bogie Plate with Short Pin
	4093.dat	~Moved to 4093a
	4093a.dat	Train Base 6 x 28 with 23 Holes
	4093c.dat	Train Base 6 x 28 with 8 Holes

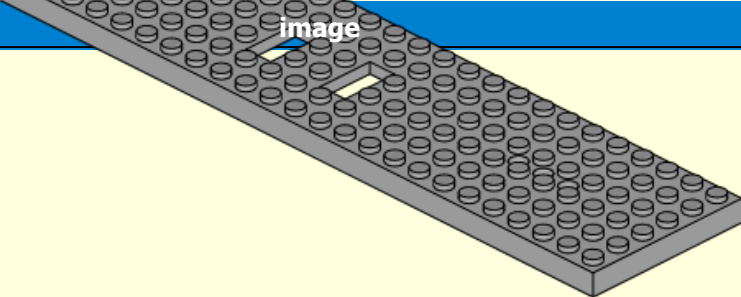




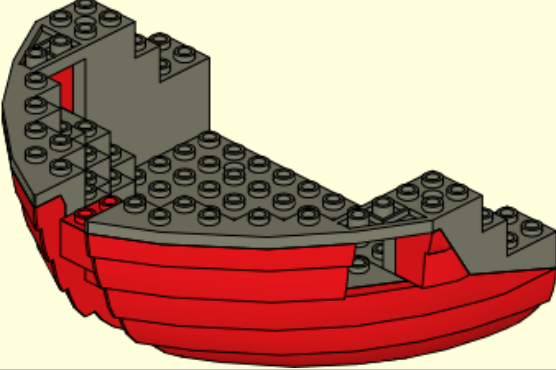
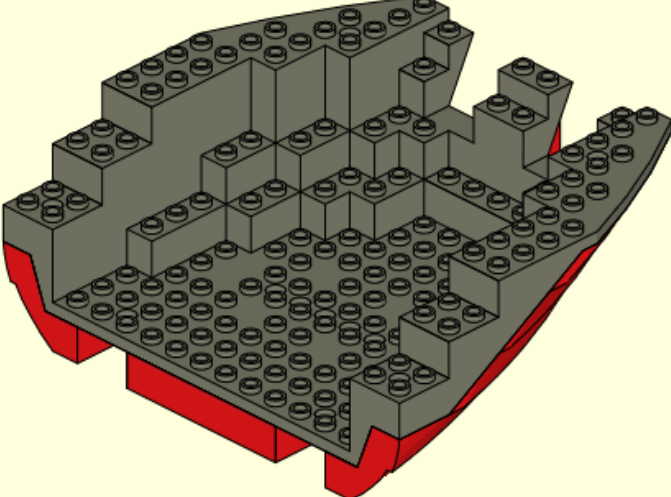
image	file	description
		
	4094a.dat	Fabuland Umbrella
	4094b.dat	Minifig Umbrella
	4095.dat	Bar 6.6L with Stop
	40996.dat	Brick 1 x 4 with Sloped Ends and Two Top Studs
	4100338.dat	_Boat Bow 16 x 12 x 5 & 1/3 Red/Dark Gray
	4100339.dat	_Boat Stern 16 x 14 x 5 & 1/3 Red/Dark Grey

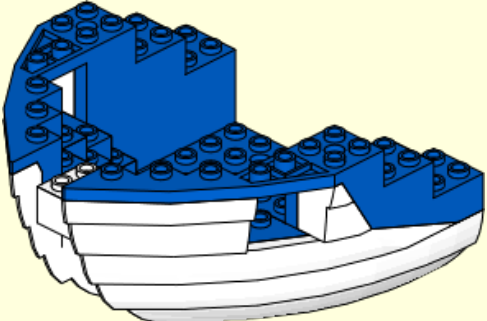
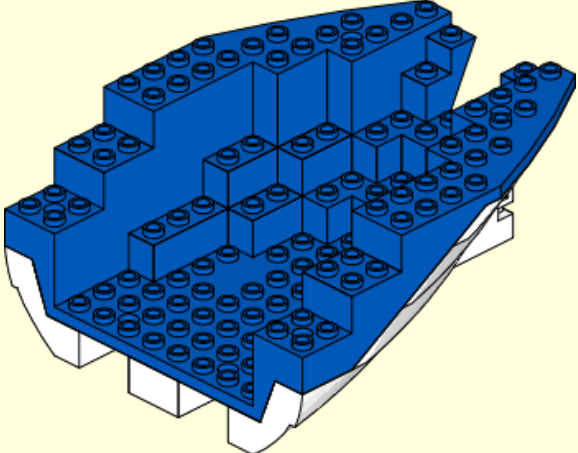
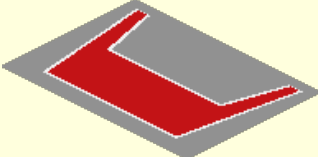
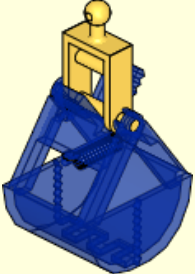





image	file	description
	4100340.dat	_Boat Bow 12 x 12 x 5 & 1/3 White/Blue
	4100341.dat	_Boat Stern 12 x 14 x 5 & 1/3 White/Blue
	4100418a.dat	Sticker 5.4 x 7.5 Red/White "V" for Air Spoiler
	4100545.dat	_Crane Grab Jaws Yellow/Trans Dark Blue (Complete)
	4105279.dat	_Flag 2 x 2 with Cavalry Logo Pattern White
	4106.dat	Magnet Cylindrical Casing
	4106330a.dat	Sticker 3.2 x 4 with "GOLD MINE" Sign
	4106332a.dat	Sticker 2.4 x 3 with Cavalry Logo
	4106332b.dat	Sticker 2.3 x 5.9 with "Fort Legoredo" Sign


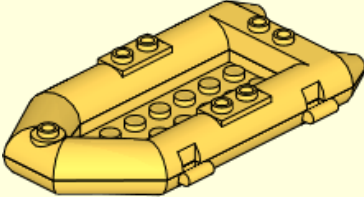

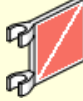





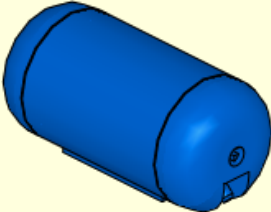
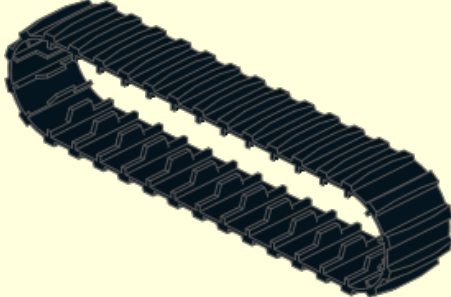
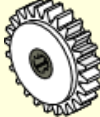


image	file	description
	4106332c.dat	Sticker 1.1 x 8 with "Headquarters" Sign
	4106548.dat	_Boat Inflatable 12 x 6 x 1.333 (Complete) Yellow
	4106592.dat	_Flag 2 x 2 with Diver Pattern White
	4106593.dat	_Flag 2 x 2 with Diver Stripe Pattern White
	4106752a.dat	Sticker 1 x 0.8 Shovel Down
	4106752b.dat	Sticker 1 x 0.8 Shovel Up
	4106752c.dat	Sticker 1 x 0.8 Shovel Arm Up
	4106752d.dat	Sticker 1 x 0.8 Shovel Arm Down
	4106981a.dat	Sticker 2.1 x 2.3 with Town TV Logo
	4107073.dat	_Technic Pneumatic Airtank Blue
	4107488.dat	_Technic Tread Black
	4107539.dat	_Technic Gear 24 Tooth Clutch White/Dark Grey
	4107623.dat	_Minifig Hips and Legs (Complete) Tan
	4107630.dat	_Minifig Feathers with Pin and Black


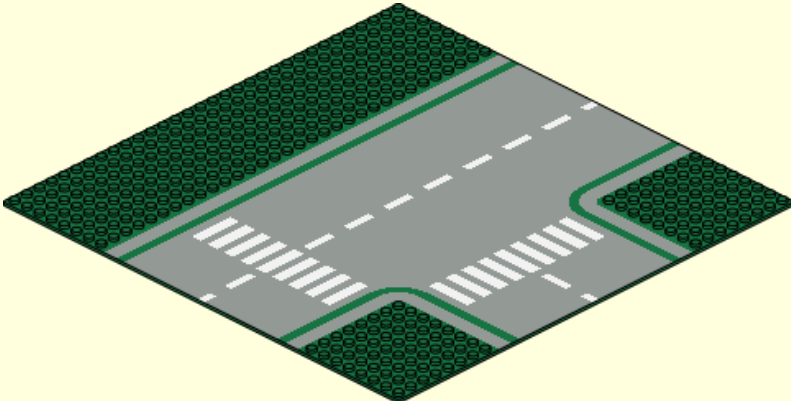
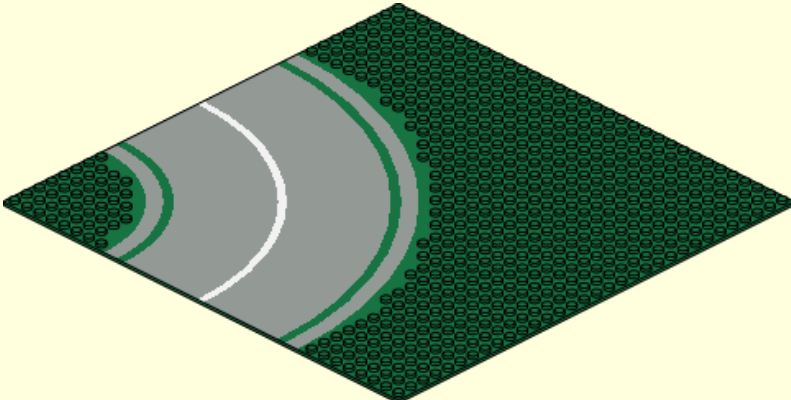
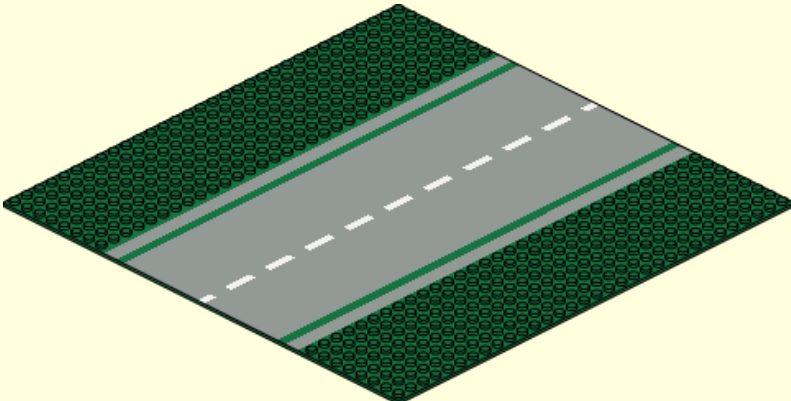
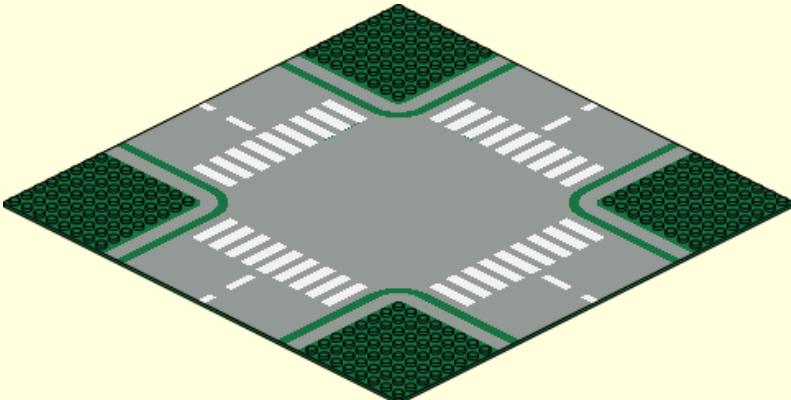
image	file	description
	4107767.dat	Tip Pattern White _Technic Angle Connector #6 (90 degree) Black
	4109600.dat	_Baseplate 32 x 32 Road 8-Stud T Intersection with Pattern
	4109601.dat	_Baseplate 32 x 32 Road 8-Stud Curve with Pattern
	4109602.dat	_Baseplate 32 x 32 Road 8-Stud Straight with Pattern
	4109603.dat	_Baseplate 32 x 32 Road 8-Stud Crossroads with Pattern


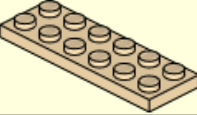
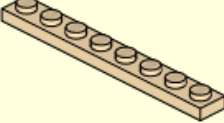











image	file	description
	4109810.dat	_Technic Axle 2 Notched Black
	4113993.dat	_Plate 2 x 6 Tan
	4114324.dat	_Plate 1 x 8 Tan
	4114505.dat	_Rock 1 x 1 Gem Facetted Trans_Neon_Green
	4116604.dat	_Brick 1 x 6 with TURBO Pattern Red
	4116679.dat	_Roadsign Clip-on 2.2 x 2.667 Triangular w/ Bend Pattern White
	4116683.dat	_Roadsign Clip-on 2.2 x 2.667 Triang. w/ Warning Patt. White
	4116688.dat	_Roadsign Clip-on 2 x 2 Square with Ped. Crossing Patt. White
	4116689.dat	_Roadsign Clip-on 2 x 2 Square w/ Speed Limit "30" Patt. White
	4116691.dat	_Roadsign Clip-on 2 x 2 Square w Black Turn Arrow Pat. Yellow
	4116692.dat	_Roadsign Clip-on 2 x 2 Square with Black Arrow Pattern Yellow
	4116859.dat	_Roadsign Clip-on 2.2 x 2.667 Triangular w/ Fire Patt. Yellow
	4118782.dat	_Plate 1 x 4 Orange
	4119056a.dat	Sticker 1 x 2 with "A41" on White/Blue






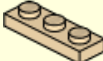
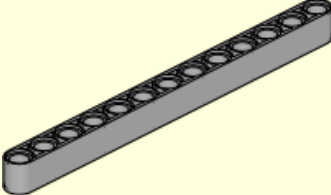


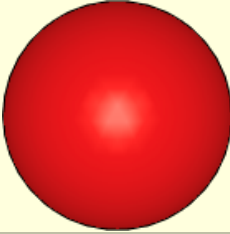





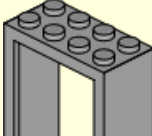
image	file	description
	4119350.dat	_Brick 1 x 1 Trans_Blue
	4119430a.dat	Sticker 3.2 x 3.2 Round Mirror
	412.dat	Arm Piece Turned with 2 and 3 Fingers
	4120158.dat	_Minifig Hips and Legs (Complete) Orange
	4121715.dat	_Technic Pin with Friction and Slots Black
	4121921.dat	_Plate 1 x 3 Tan
	41239.dat	Technic Beam 13
	4124174.dat	_Brick 4 x 4 Round with Holes Yellow
	4124456.dat	_Tile 1 x 2 Grille with Groove Tan
	41250.dat	_Ball 52mm Diameter Red
	4125254.dat	_Tile 1 x 2 Grille with Groove Orange
	4128503.dat	_Technic Turntable 5 x 5 (Complete) Blue
	4129790a.dat	Sticker 1.2 x 4 with 7 Black Squares
	4129790b.dat	Sticker 1.2 x 6 with White "P&O Stena" on Blue
	4129790c.dat	Sticker 2.4 x 3 with Stena Flag
	4130.dat	Door 2 x 4 x 5 Frame

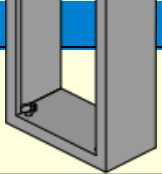
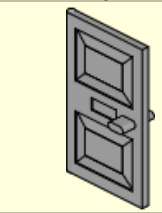
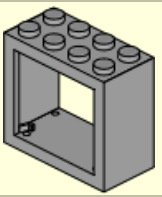
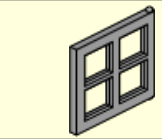

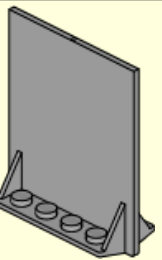


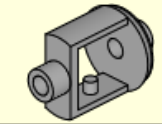
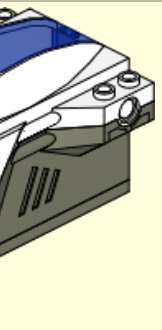

image	file	description
		
	4131.dat	Door 2 x 4 x 5
	4132.dat	Window 2 x 4 x 3
	4133.dat	Window 2 x 4 x 3 Pane
	41334.dat	Minifig Hat Knit Cap
	41357.dat	Door 2 x 8 x 6 Revolving with Shelf Supports
	4140643.dat	_Znap Connector 3 x 3 - 4 Way Closed w. Rotating Black/Yellow
	4140801.dat	_Technic Pin Long with Stop Bush Black
	4141.dat	~Technic Differential Casing
	4141498.dat	_Electric Technic Micro-Scout White/Dark Grey
	4142.dat	~Technic Differential Crown Wheel 28


















image	file	description
		Tooth
	4143.dat	Technic Gear 14 Tooth Bevel
	4143005.dat	_Technic Pin 1/2 Blue
	415.dat	~Moved to 6217
	4150.dat	Tile 2 x 2 Round
	4150c07.dat	Tile 2 x 2 Round with Lifepreserver Sticker (Shortcut)
	4150p00.dat	Tile 2 x 2 Round with Film/Tape Reel Pattern
	4150p01.dat	Tile 2 x 2 Round with Grille Pattern
	4150p02.dat	Tile 2 x 2 Round with Pizza Pattern
	4150p03.dat	Tile 2 x 2 Round with Clock Pattern
	4150p04.dat	Tile 2 x 2 Round with Yellow Arrow with Black Border Pattern
	4150p05.dat	Tile 2 x 2 Round with Black Exhaust Port Pattern
	4150p07.dat	~Moved to 4150c07
	4150p30.dat	Tile 2 x 2 Round with Zebra Stripes Pattern
	4150p40.dat	Tile 2 x 2 Round with Archery Target Pattern
	4150pf0.dat	Tile 2 x 2 Round with Red Rings Pattern
	4150ps0.dat	Tile 2 x 2 Round with Hexagonal Hatch Pattern
	4150ps1.dat	Tile 2 x 2 Round with SW Red & Black Vent Pattern
	4150ps2.dat	Tile 2 x 2 Round with SW Sith Infiltrator Pattern








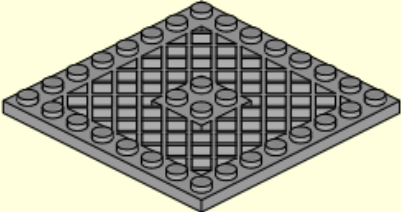
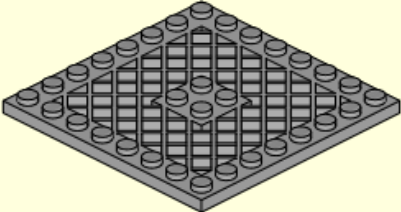
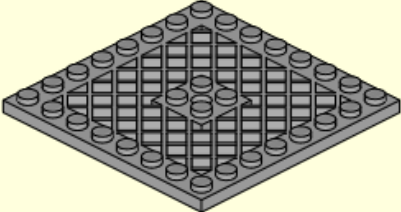


image	file	description
	4150ps3.dat	Tile 2 x 2 Round with Star Wars Dejarik Hologame Board Pattern
	4150ps4.dat	Tile 2 x 2 Round with Star Wars Millennium Falcon Vent Pattern
	4150ps5.dat	Tile 2 x 2 Round with SW Imperial Pattern
	4150ps6.dat	Tile 2 x 2 Round with SW Galactic Republic Pattern
	4150ps7.dat	Tile 2 x 2 Round with Hatch Pattern
	4150ps8.dat	Tile 2 x 2 Round with Grey and Black Machinery Pattern
	4150ps9.dat	Tile 2 x 2 Round with Vent Pattern
	4151.dat	~Moved to 4151a
	4151a.dat	Plate 8 x 8 with Grille without Hole
	4151b.dat	Plate 8 x 8 with Grille and Hole
	41529.dat	Hinge Wedge 1 x 3 Locking with 2 Fingers, 2 Studs and Clip
	41530.dat	Propellor 8 Blade 5 Diameter

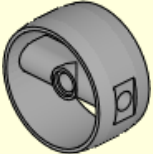

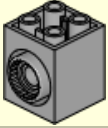
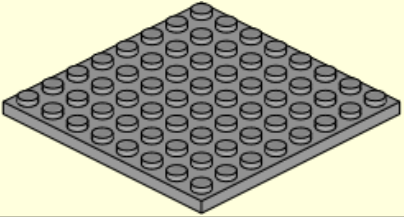


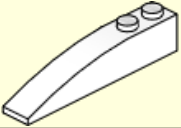

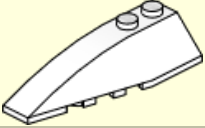



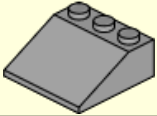

image	file	description
	41531.dat	Technic Cylinder 4 x 4 x 2 with 3 Pin Holes and Center Bar
	41532.dat	Hinge Arm Locking with Single Finger and Friction Pin
	41533.dat	Brick 2 x 2 x 2 with 2 Holes and Click Rotation Ring
	41539.dat	Plate 8 x 8
	4155708.dat	_Plate 1 x 2 with 1 Stud Tan
	4158884a.dat	Sticker 3.2 x 3.2 Round with "9 3/4"
	4160101.dat	_Wedge 2 x 6 Double Right White
	4160108.dat	_Wedge 2 x 6 Double Right Black
	4160124.dat	_Wedge 2 x 6 Double Left White
	4160130.dat	_Wedge 2 x 6 Double Left Black
	4160409.dat	_Slope Brick Curved 6 x 1 Inverted Black
	4160689.dat	_Technic Pulley Wheel 5D White
	4161.dat	Slope Brick 33 3 x 3
	4161103.dat	_Minifig Feathers with Pin and Black

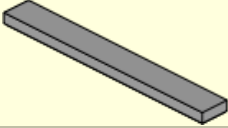
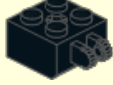


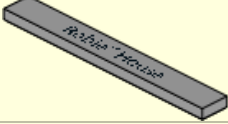
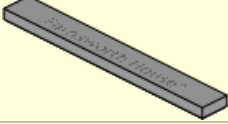
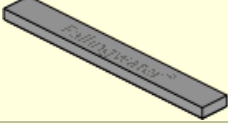


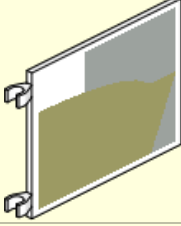
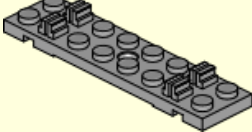
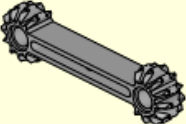
image	file	description
		Tip Pattern White
	4162.dat	Tile 1 x 8
	4162235.dat	_Hinge Brick 2 x 2 Locking with Axlehole and Dual Finger Black
	4162628.dat	_Slope Brick 75 2 x 1 x 3 Red
	4162916.dat	_Minifig Hips and Legs (Complete) Dark Blue
	4162p01.dat	Tile 1 x 8 with "Robie House" Pattern
	4162p02.dat	Tile 1 x 8 with "Farnsworth House" Pattern
	4162p03.dat	Tile 1 x 8 with "Fallingwater" Pattern
	4162p04.dat	Tile 1 x 8 with "The White House" Pattern
	4162p05.dat	Tile 1 x 8 with "Burj Khalifa" Pattern
	4164290.dat	_Flag 6 x 4 with SW Jedi Starfighter Pattern White
	4166.dat	Train Track Sleeper Plate 2 x 8 with Cable Grooves
	41666.dat	Technic Arm 1 x 6 with Gear 12 Tooth Double Bevel Ends

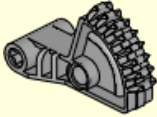


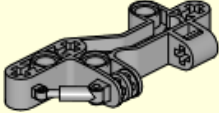



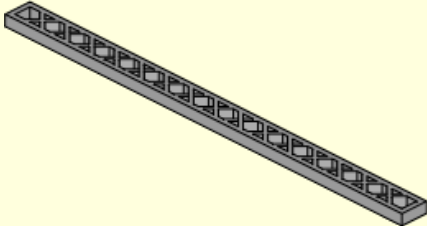

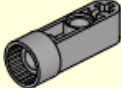

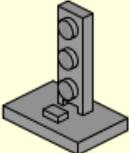
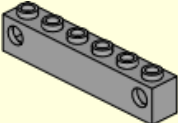
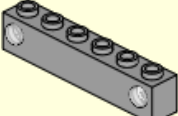
image	file	description
	41667.dat	Technic Arm 3 x 2 with Gear 36 Tooth Double Bevel Quarter
	41669.dat	Technic Tooth 1 x 3 with Axlehole
	41670.dat	Technic Bionicle Leg 4 x 4 with Two Ball Joints
	41672.dat	Technic Beam 1 x 3 x 7 with 4 Axleholes and 3 Holes
	41677.dat	Technic Beam 2 x 0.5 Liftarm
	41678.dat	Technic Cross Block 2 x 2 Split (Axle/Twin Pin)
	41679.dat	Technic Beam 4 x 0.5 Liftarm with Click Rotation Hinge Half
	4168.dat	Train Signal Mast
	41680.dat	Technic Pin with Friction with Click Rotation Ring
	41681.dat	Technic Beam 3.8 x 1 Liftarm with Click Rotation Ring Socket
	4168950.dat	_Minifig Hips and Legs (Complete) Dark Red/Black
	4169.dat	Train Signal Stand
	4170.dat	~Electric Light Prism 1 x 6 Holder
	4170c01.dat	Electric Light Prism 1 x 6 Holder (Complete)

image	file	description
	4171.dat	Electric Train Light Prism 1 x 3
	4171849.dat	_Slope Brick Curved Top 2 x 2 x 1 Blue
	41732.dat	Technic Pin Joiner Round with Slot, Bar and Pivot
	41747.dat	Wedge 2 x 6 Double Right
	4174735a.dat	Sticker 2.8 x 2.8 Round Train Fan
	41747pq0.dat	Wedge 2 x 6 Double Right with Bricks and Hieroglyphs Pattern
	41747ps1.dat	Wedge 2 x 6 Double Right with AT-TE Pattern
	41748.dat	Wedge 2 x 6 Double Left
	41748pq0.dat	Wedge 2 x 6 Double Left with Bricks and Hieroglyphs Pattern
	41748ps1.dat	Wedge 2 x 6 Double Left with AT-TE Pattern
	41749.dat	Slope Brick Round 3 x 8 x 2 Right
	4175.dat	Plate 1 x 2 with Ladder
	41750.dat	Slope Brick Round 3 x 8 x 2 Left
	41751.dat	Windscreen 8 x 6 x 2 Curved

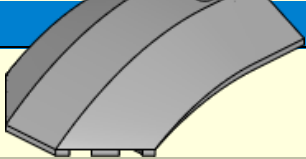
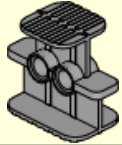
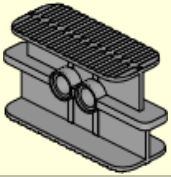
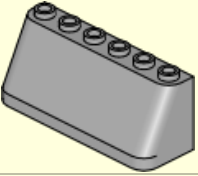
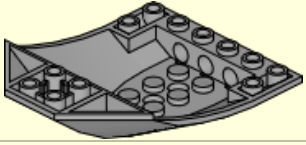
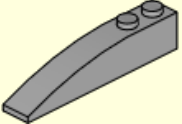
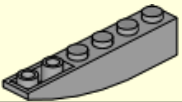
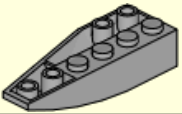
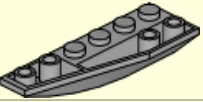
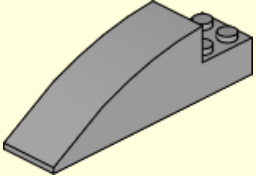
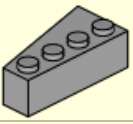
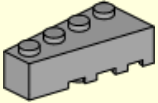
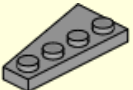
image	file	description
		
	41752.dat	Technic Rubber Band Holder Small with Pinholes
	41753.dat	Technic Rubber Band Holder Large with Pinholes
	4176.dat	Windscreen 2 x 6 x 2
	41761.dat	Wedge 6 x 8 x 2 Triple Inverted
	41762.dat	Slope Brick Curved 6 x 1
	41763.dat	Slope Brick Curved 6 x 1 Inverted
	41764.dat	Wedge 2 x 6 Double Inverted Right
	41765.dat	Wedge 2 x 6 Double Inverted Left
	41766.dat	Slope Brick Curved 8 x 2 x 2
	41767.dat	Wedge 4 x 2 Right
	41768.dat	Wedge 4 x 2 Left
	41769.dat	Wing 2 x 4 Right

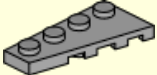

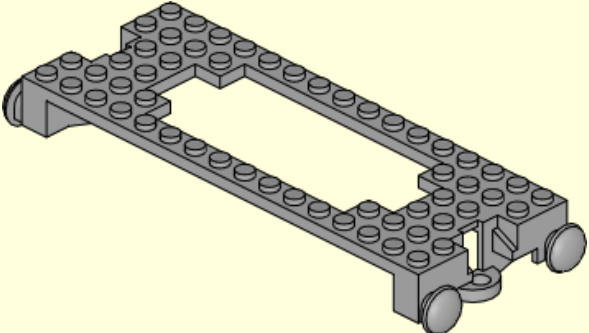
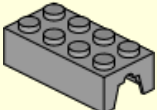
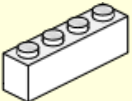
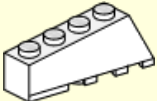
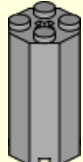
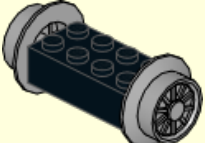


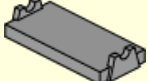
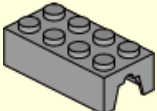

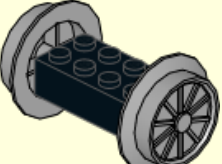
image	file	description
	41770.dat	Wing 2 x 4 Left
	4177932.dat	_Plate 1 x 2 Orange
	4178.dat	Train Base 6 x 16
	4179.dat	~Brick 2 x 4 for Train Wheels Top
	4179872.dat	_Wedge 4 x 2 Sloped Right White
	4179873.dat	_Wedge 4 x 2 Sloped Left White
	418.dat	~Moved to 6037
	4180.dat	~Moved to 4180c02
	4180508.dat	_Wing 2 x 3 Right Black
	4180536.dat	_Wing 2 x 3 Left Black
	4180a.dat	~Brick 2 x 4 for Train Wheels Base
	4180b.dat	~Moved to 4179
	4180c.dat	~Moved to 2344
	4180c01.dat	Brick 2 x 4 Black with Train Wheels Large (Complete)

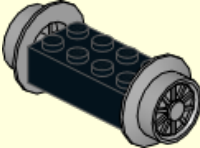


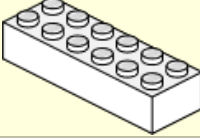

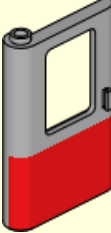



image	file	description
	4180c02.dat	Brick 2 x 4 Black with Train Wheels Small (Complete)
	4180d.dat	~Moved to 996
	4181.dat	Train Door 1 x 4 x 5 Left
	4181142.dat	_Brick 2 x 6 White
	4181p01.dat	Train Door 1 x 4 x 5 Left with Yellow Bottom Half Pattern
	4181p02.dat	Train Door 1 x 4 x 5 Left with Red Bottom Half Pattern
	4181p02d02.dat	Train Door 1 x 4 x 5 Left Red Bottom Half w/ Mail Sticker
	4181p03.dat	Train Door 1 x 4 x 5 Left with White Stripe Pattern
	4181p04.dat	Train Door 1 x 4 x 5 Left with Red/White/Blue Stripe Pattern

image	file	description
		
	4181p05.dat	Train Door 1 x 4 x 5 Left with Blue Bottom Half Pattern
	4181p06.dat	Train Door 1 x 4 x 5 Left with Red/Blue Stripe Pattern
	4181p07.dat	Train Door 1 x 4 x 5 Left with Yellow Stripe Pattern
	4182.dat	Train Door 1 x 4 x 5 Right
	4182p01.dat	Train Door 1 x 4 x 5 Right with Yellow Bottom Half Pattern
	4182p02.dat	Train Door 1 x 4 x 5 Right with Red Bottom Half Pattern
	4182p02d02.dat	Train Door 1 x 4 x 5 Right Red Bottom Half w/ Mail Sticker

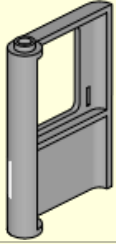
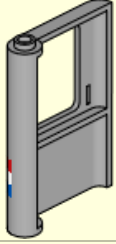
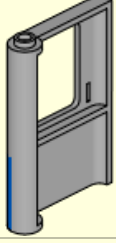
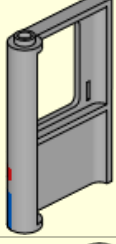
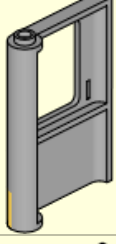




image	file	description
	4182p03.dat	Train Door 1 x 4 x 5 Right with White Stripe Pattern
	4182p04.dat	Train Door 1 x 4 x 5 Right with Red/White/Blue Stripe Pattern
	4182p05.dat	Train Door 1 x 4 x 5 Right with Blue Bottom Half Pattern
	4182p06.dat	Train Door 1 x 4 x 5 Right with Red/Blue Stripe Pattern
	4182p07.dat	Train Door 1 x 4 x 5 Right with Yellow Stripe Pattern
	4183.dat	Glass for Train Door
	4183043.dat	_Hinge Plate 1 x 2 Locking w/ Single Finger on End Vert. Black
	4183048.dat	_Hinge Plate 1 x 2 Locking with Dual Finger on End Vert. White
	41837.dat	~Spring for Technic Shock Absorber 6.5L Soft




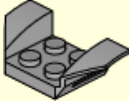


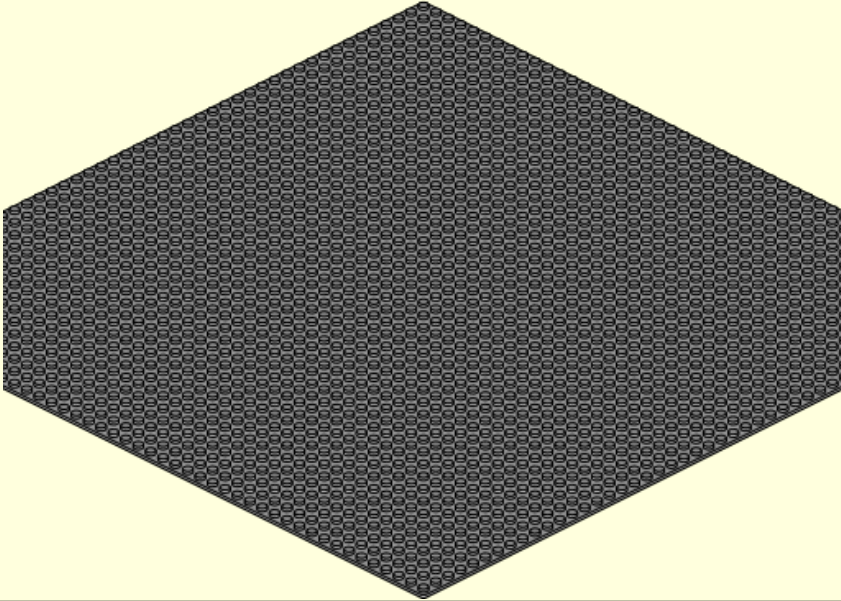

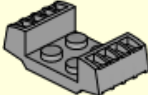
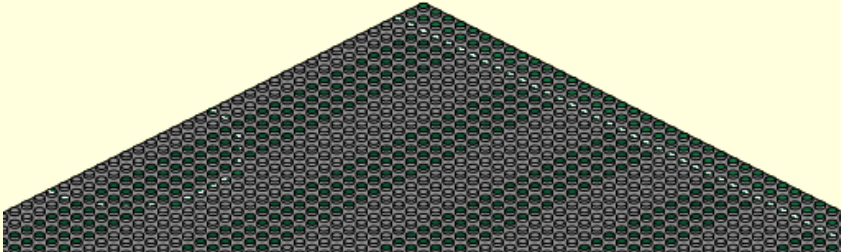
image	file	description
	41838.dat	Technic Shock Absorber 6.5L Soft (Complete)
	4185.dat	Technic Wedge Belt Wheel
	4185177.dat	_Tile 2 x 2 with Groove Tan
	41854.dat	Car Mudguard 2 x 4 Swept Back
	4185495.dat	_Minifig Hips and Legs with Buttoned Pockets (Complete) Tan
	41855.dat	Slope Brick Round 2 x 2 x 2/3
	4186.dat	Baseplate 48 x 48
	4186017.dat	_Technic Axle Pin Tan
	41862.dat	Plate 2 x 2 With Raised Grilles
	4186p01.dat	Baseplate 48 x 48 with Playing Field Pattern

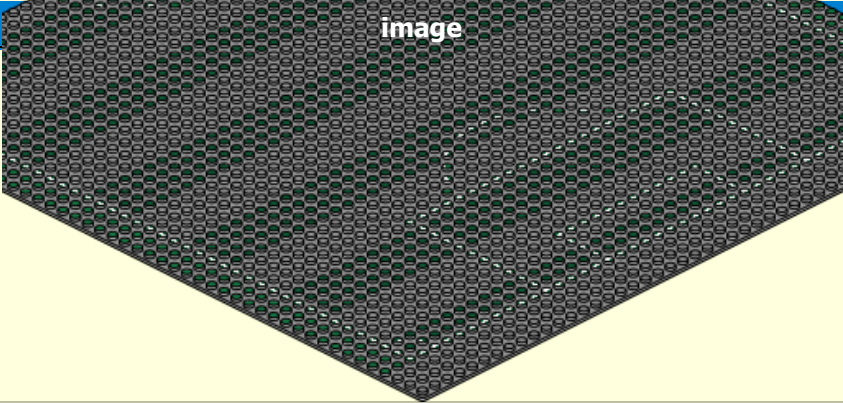
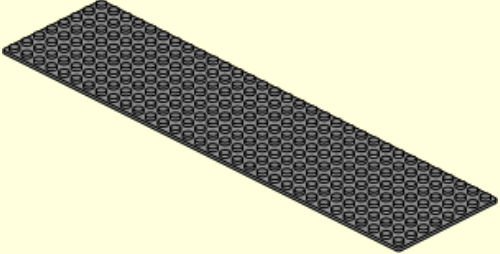



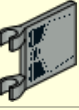
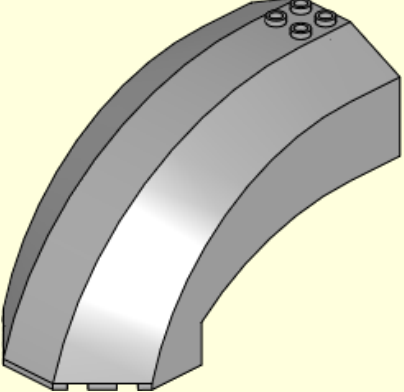
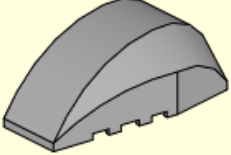
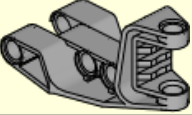

image	file	description
		
	4187.dat	Baseplate 8 x 32
	4187750.dat	_Dish 2 x 2 Inverted Trans Clear
	41879.dat	Minifig Hips and Legs Short
	41880.dat	Minifig Head Yoda with Curved Ears
	4188055.dat	_Flag 2 x 2 with SW Mini AT-ST Pattern LtGrey
	41881.dat	Windscreen 12 x 6 x 6 Curved
	41883.dat	Windscreen 6 x 4 x 2 Canopy Curved
	41894.dat	Technic Steering Arm Large with Four Holes
	41894c01.dat	Technic Steering Arm With 2 Ball Joints (Complete)

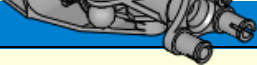
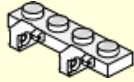


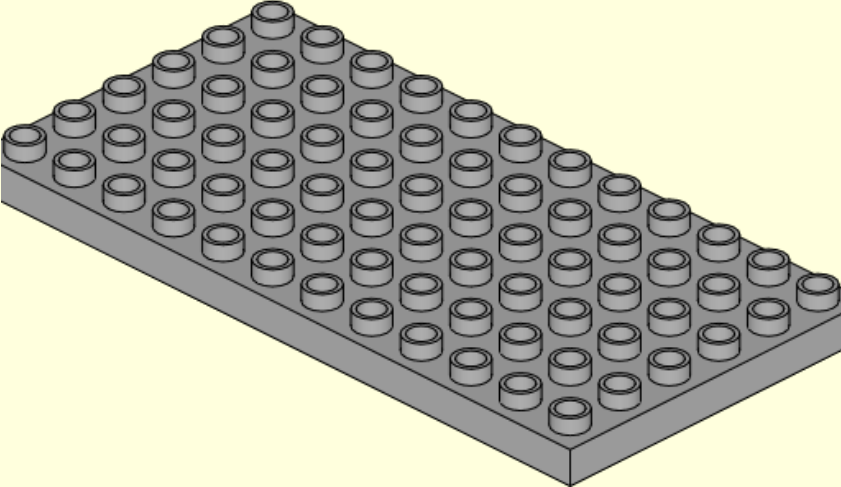
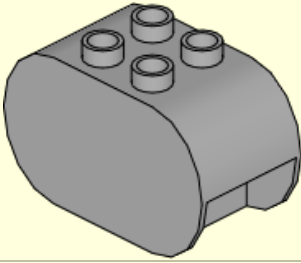

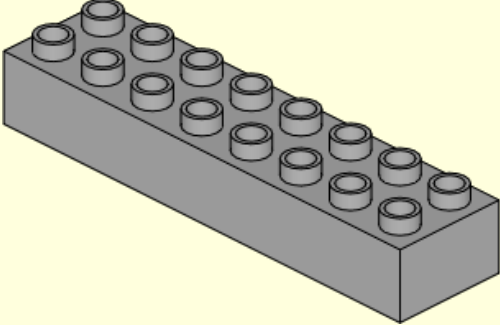
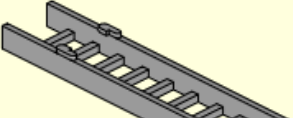
image	file	description
	41895.dat	Technic Steering Arm with 2 Ball Joints
	4193479.dat	_Hinge Plate 1 x 4 Locking with Two Fingers On Side White
	4193528.dat	_Brick 4 x 4 Round with Holes Yellow
	4195004.dat	_Slope Brick 45 1 x 2 Triple Red
	4196.dat	Duplo Plate 6 x 12
	4198.dat	Duplo Brick 2 x 4 x 2 with Rounded Ends
	4198367.dat	_Technic Axle Joiner Double Flexible Rubber_Black
	4199.dat	Duplo Brick 2 x 8
	420.dat	Ladder Two Piece, Bottom Section

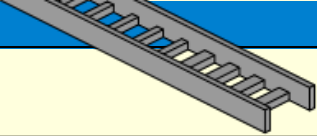

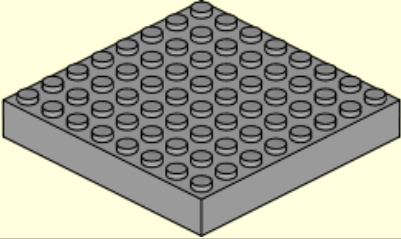
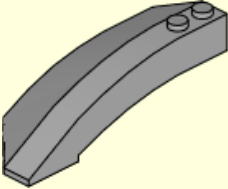
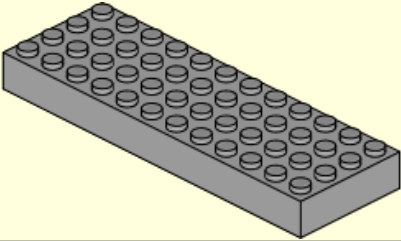
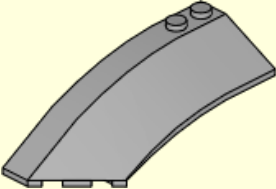
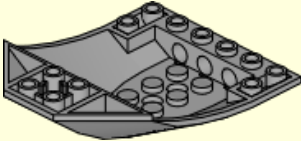
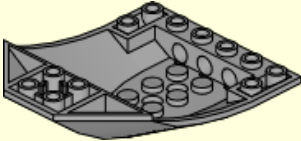
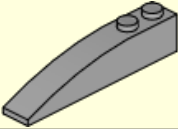
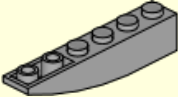
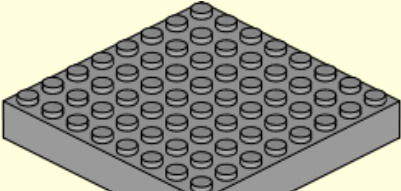
image	file	description
		
	42003.dat	Technic Cross Block 1 x 3 (Axle/Pin/Pin)
	4201.dat	Brick 8 x 8
	42019.dat	Slope Brick Round 3 x 8 x 2 Right
	4202.dat	Brick 4 x 12
	42020.dat	Slope Brick Round 3 x 8 x 2 Left
	42021.dat	Wedge 6 x 8 x 2 Triple Inverted
	42021d01.dat	Wedge 6 x 8 x 2 Triple Inverted with Joker Face Sticker
	42022.dat	Slope Brick Curved 6 x 1
	42023.dat	Slope Brick Curved 6 x 1 Inverted
	4203.dat	~Moved to 4201

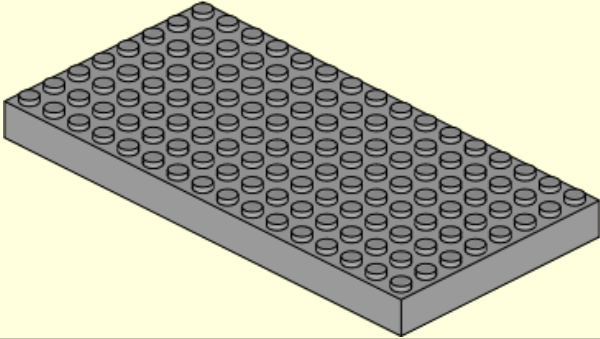
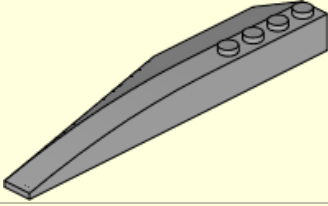
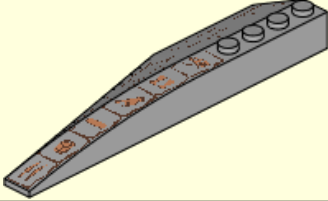
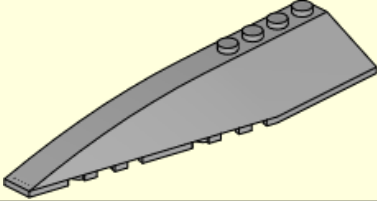
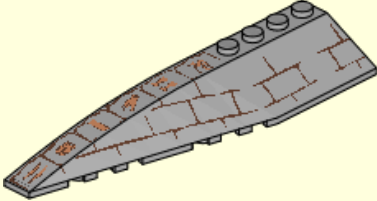


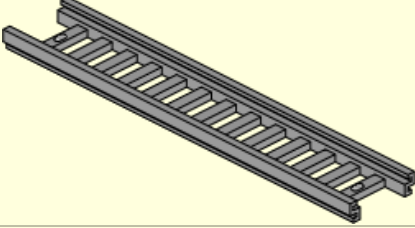

image	file	description
	4204.dat	Brick 8 x 16
	42060.dat	Wedge 12 x 3 x 1 Double Rounded Right
	42060pq0.dat	Wedge 12 x 3 Double Right with Bricks & Hieroglyphs Pattern
	42061.dat	Wedge 12 x 3 x 1 Double Rounded Left
	42061pq0.dat	Wedge 12 x 3 Double Left with Bricks & Hieroglyphs Pattern
	4206482.dat	_Technic Axle Pin with Friction Blue
	4206504.dat	_Minifig Hips and Legs (Complete) Sand Green
	4207.dat	Ladder 2.5 x 14
	42074.dat	Technic Bionicle Hook Small with Axle and Hole

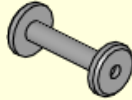
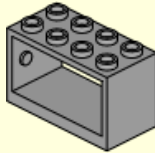
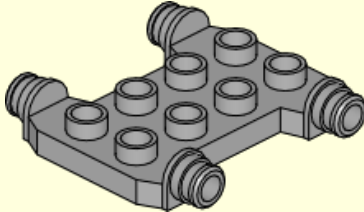
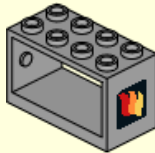
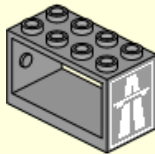
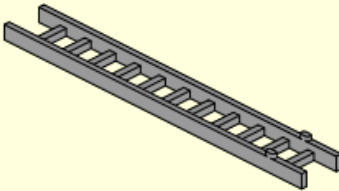
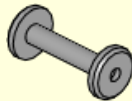






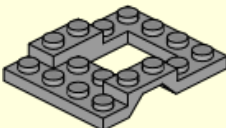
image	file	description
	4208.dat	Hose Reel 2 x 4 x 2 Drum (Needs work)
	4209.dat	Hose Reel 2 x 4 x 2 Holder
	42092.dat	~Duplo Vehicle Base 2 x 4 with Stub Axles
	4209p01.dat	Hose Reel 2 x 4 x 2 Holder with Fire Logo Pattern
	4209p05.dat	Hose Reel 2 x 4 x 2 Holder with Motorway Logo Pattern
	421.dat	Ladder Two Piece, Top Section
	4210.dat	~Moved to 4208
	4210531.dat	_Tile 1 x 2 Grille with Groove Black
	4210633.dat	_Plate 1 x 1 Round Dark_Bluish_Gray
	4210698.dat	_Minifig Loudhailer Dark_Bluish_Gray
	4210883.dat	_Hinge Plate 1 x 2 Locking with Single Finger Vertical [72]
	42109.dat	Minifig Head Goblin
	4210a.dat	Minifig Tool Hose Nozzle with Handle
	4211.dat	Car Base 4 x 5






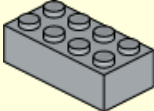

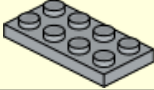








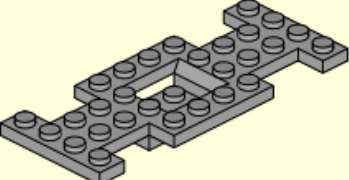
image	file	description
	4211044.dat	_Brick 1 x 1 with Headlight Dark_Bluish_Gray
	4211063.dat	_Plate 1 x 2 Dark_Bluish_Gray
	4211069.dat	_Tile 1 x 1 with Clip Dark_Bluish_Gray
	4211119.dat	_Plate 1 x 2 with 1 Stud Dark_Bluish_Gray
	4211152.dat	_Plate 1 x 3 Reddish_Brown
	4211385.dat	_Brick 2 x 4 Light_Bluish_Gray
	4211388.dat	_Brick 1 x 2 Light_Bluish_Gray
	4211395.dat	_Plate 2 x 4 Light_Bluish_Gray
	4211396.dat	_Plate 2 x 3 Light_Bluish_Gray
	4211477.dat	_Plate 1 x 1 with Clip Light - Type 2 Light_Bluish_Gray
	4211550.dat	_Technic Angle Connector #1 Light_Bluish_Gray
	4211573.dat	_Technic Bush 1/2 Smooth Light_Bluish_Gray
	4211622.dat	_Technic Bush Light_Bluish_Gray
	4211807.dat	_Technic Pin Light_Bluish_Gray
	4211814.dat	_Hinge Plate 1 x 2 Locking with 1 Finger On Side Vertical [71]
	4211815.dat	_Technic Axle 3 Light_Bluish_Gray
	4212.dat	~Moved to 4212b


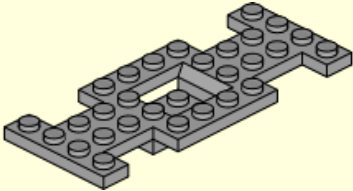
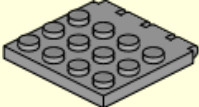
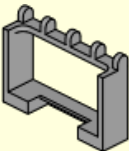

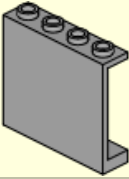
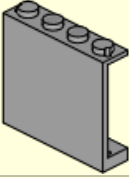

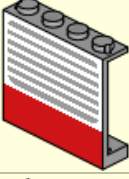
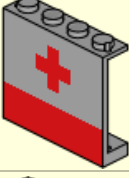
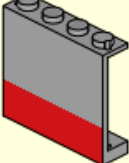
image	file	description
	4212454.dat	_Brick 1 x 1 Round with Hollow Stud Lime
	4212b.dat	Car Base 4 x 10 x 0.667 with 2 x 2 Center Open
	4213.dat	Hinge Car Roof 4 x 4
	4214.dat	Hinge Car Roof Holder 1 x 4 x 2
	4214921.dat	_Minifig Hips and Legs (Complete) Dark Grey/Orange
	4215.dat	~Moved to 4215b
	4215a.dat	Panel 1 x 4 x 3
	4215ad01.dat	Panel 1 x 4 x 3 with Solid Studs and Mail Sticker
	4215ap01.dat	Panel 1 x 4 x 3 with Red Bar and White Grille Pattern
	4215ap02.dat	Panel 1 x 4 x 3 with Red Cross and Stripe Pattern
	4215ap03.dat	Panel 1 x 4 x 3 with Red Stripe Pattern

image	file	description
	4215ap04.dat	Panel 1 x 4 x 3 Right with Blue Stripe Pattern
	4215ap05.dat	Panel 1 x 4 x 3 Right with Red/Blue Stripe Pattern
	4215ap06.dat	Panel 1 x 4 x 3 Left with Blue Stripe Pattern
	4215ap07.dat	Panel 1 x 4 x 3 Left with Red/Blue Stripe Pattern
	4215ap08.dat	Panel 1 x 4 x 3 with Red Recycling Pattern
	4215ap09.dat	Panel 1 x 4 x 3 with White "TV" Logo Pattern
	4215ap18.dat	Panel 1 x 4 x 3 with "POLICE" and White Grille Pattern
	4215ap19.dat	Panel 1 x 4 x 3 with Blue Snowflake Pattern
	4215ap24.dat	Panel 1 x 4 x 3 with Lower-Right Black Triangle Pattern
	4215ap25.dat	Panel 1 x 4 x 3 with Lower-Left Black Triangle Pattern

image	file	description
	4215ap30.dat	Panel 1 x 4 x 3 with Black Jolly Roger Pattern
	4215ap66.dat	Panel 1 x 4 x 3 with Red Cross Pattern
	4215b.dat	Panel 1 x 4 x 3 with Hollow Studs
	4215bd01.dat	Panel 1 x 4 x 3 with Hollow Studs w Joker Face Sticker Inside
	4215p01.dat	~Moved to 4215ap01
	4215p02.dat	~Moved to 4215ap02
	4215p03.dat	~Moved to 4215ap03
	4215p04.dat	~Moved to 4215ap04
	4215p05.dat	~Moved to 4215ap05
	4215p06.dat	~Moved to 4215ap06

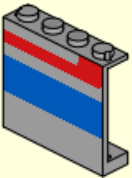
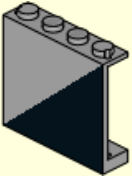
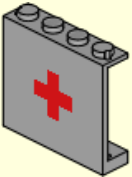
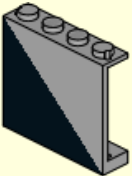





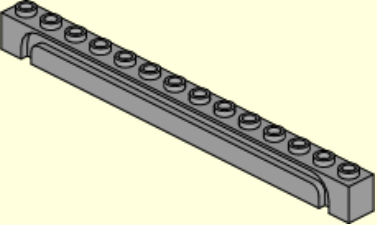
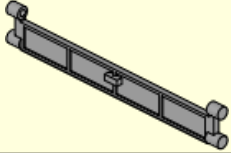

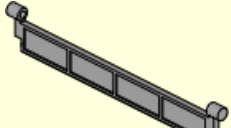
image	file	description
	4215p07.dat	~Moved to 4215ap07
	4215p24.dat	~Moved to 4215ap24
	4215p66.dat	~Moved to 4215ap66
	4215p77.dat	~Moved to 4215ap25
	4216.dat	Brick 1 x 2 with Groove
	4216384.dat	_Tile 1 x 1 with Groove Trans Green
	4216695.dat	_Plate 2 x 2 Reddish_Brown
	4216816a.dat	Sticker 1.6 x 1.8 with US Flag Pattern
	4216816b.dat	Sticker 1.6 x 1.8 with US Flag Pattern (Mirrored)
	4217.dat	Brick 1 x 14 with Groove
	4218.dat	~Moved to 4219a
	4218868.dat	_Technic Disc 3 x 3 with Axlehole Black
	4218a.dat	Roller Door Normal

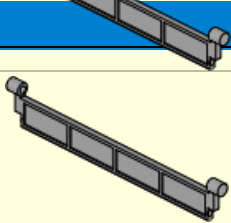
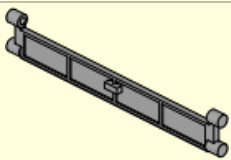




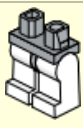


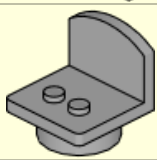
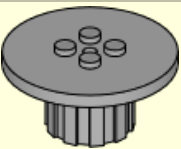

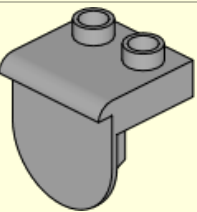

image	file	description
	4219.dat	~Moved to 4218a
	4219a.dat	Roller Door with Handle
	422.dat	Plate 2 x 2 with Axle Brackets
	4220.dat	Grab Jaw Holder
	4221.dat	Grab Jaw
	4221774.dat	_Turntable 2 x 2 Plate (Complete) Black/Medium Stone Grey
	4221858.dat	_Minifig Hips and Legs (Complete) Medium Stone/White
	4221886.dat	_Minifig Hips and Legs (Complete) Reddish Brown
	4222693.dat	_Minifig Hips and Legs (Complete) Dark Stone
	4222a.dat	Fabuland Chair
	4223.dat	Fabuland Table
	4223189.dat	_Minifig Goblet Black
	42236.dat	Duplo Plate 1 x 2 with Overhang (Needs Work)
	4224792.dat	_Plate 1 x 1 with Tooth White




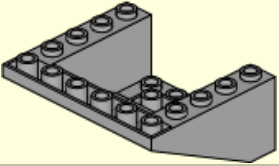

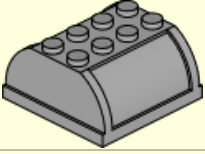



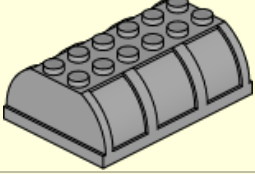

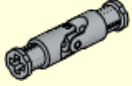
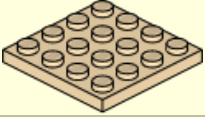

image	file	description
	4225787.dat	_Minifig Hips and Legs (Complete) Dark Stone Grey/Reddish Brown
	4226869.dat	_Minifig Hips and Legs (Complete) Dark Green
	4226995.dat	_Car Steering Stand and Wheel (Complete) Light_Bluish_Gray
	4228.dat	Slope Brick 33 5 x 6 x 2 Inverted
	4229.dat	Plate 2 x 2 with Jet Engine
	4231.dat	Container 4 x 4 x 1.667 Lid
	4234.dat	Motor Wind-Up 4 x 10 x 3 Key
	4234927.dat	_Wing 4 x 4 with 2 x 2 Cutout Yellow
	4234932.dat	_Wing 4 x 4 with 2 x 2 Cutout Black
	4238.dat	Container 4 x 6 x 1.667 Lid
	424.dat	~Moved to 6221
	4240416.dat	_Technic Universal Joint (Complete Assembly Shortcut) Stone Gray
	4243824.dat	_Plate 4 x 4 Tan
	42443.dat	Minifig Headdress Werewolf


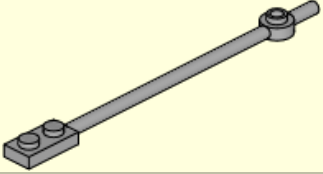

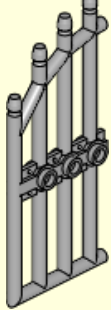
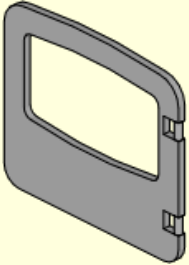

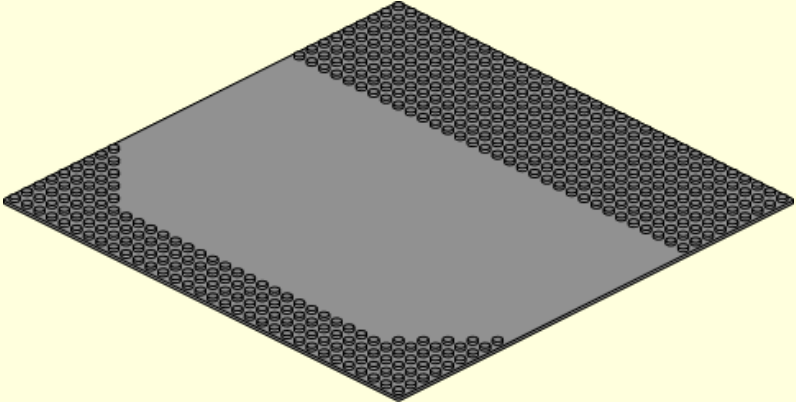


image	file	description
	4244362.dat	_Slope Brick 31 1 x 1 x 0.667 Trans Clear
	42445.dat	Bar 12L with Plate 1 x 2 and Hollow Stud
	42446.dat	Bracket 1 x 1 - 1 x 1
	42448.dat	Gate 1 x 4 x 9 Arched with Bars
	4247.dat	Duplo Door 1 x 4 x 3 with Large Window
	4247772.dat	_Slope Brick Curved 8 x 1 x 1.667 with Arch Red
	425.dat	Baseplate 32 x 32 Road 9-Stud Layby
	42511.dat	Minifig Skateboard with Four Wheel Clips
	4251162.dat	_Slope Brick Curved 3 x 1 Red


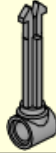


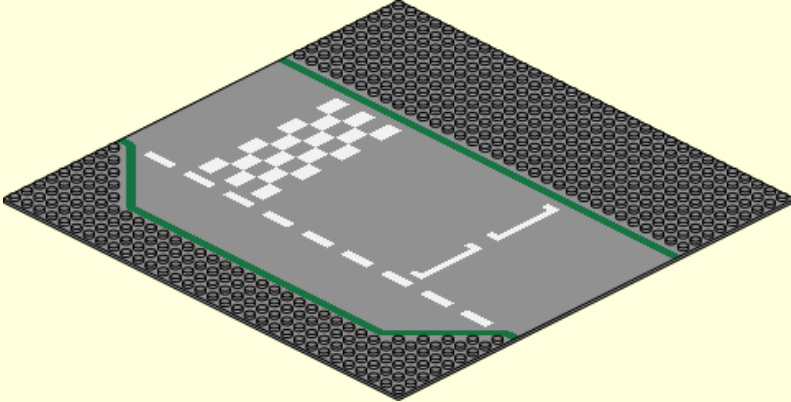
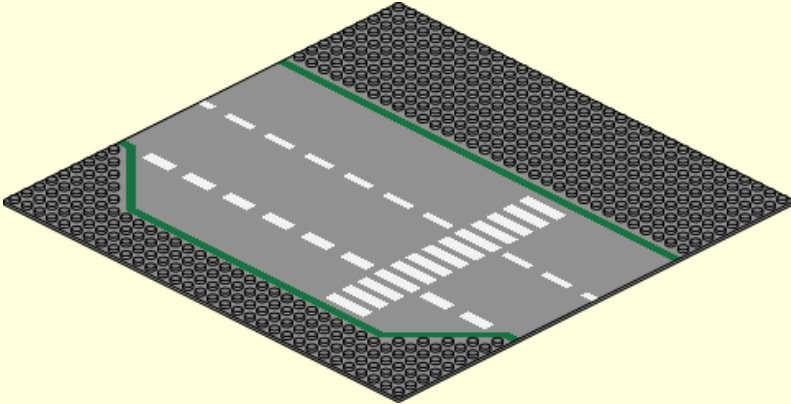
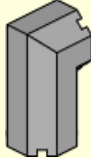
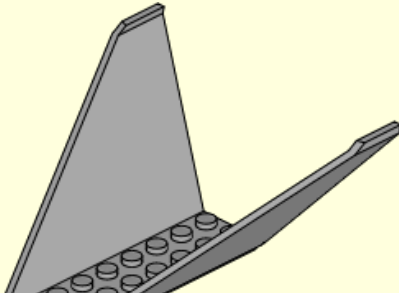
image	file	description
	42511c01.dat	Minifig Skateboard with Black Wheels (Complete)
	4254.dat	~Technic Shock Absorber 6.5L Piston Rod
	4255.dat	~Technic Shock Absorber 6.5L Cylinder
	4256738.dat	_Brick 4 x 4 Round with Holes Yellow
	425p01.dat	Baseplate 32 x 32 Road 9-Stud Layby with Racetrack Pattern
	425p02.dat	Baseplate 32 x 32 Road 9-Stud Layby with Crosswalk Pattern
	426.dat	~Moved to 6043
	42603.dat	Tail 10 x 10 x 4 Twin

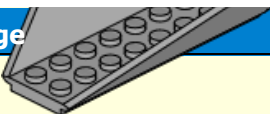
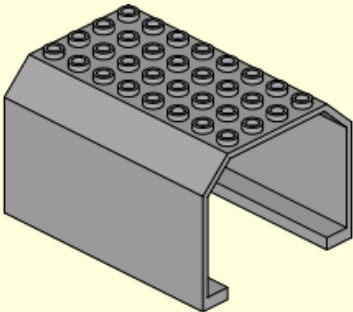
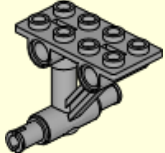



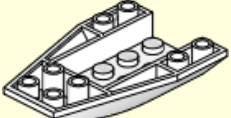
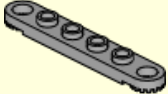







image	file	description
 	42604.dat	Panel 6 x 8 x 4 Fuselage
	42608.dat	Plate 2 x 4 with Holes and Pins
	4261.dat	Technic Steering Arm
	42610.dat	Wheel Hub 8 x 11.2 with Centre Groove
	4261453.dat	_Technic Cross Block 1 x 2 (Axle/Pin) Lime
	4261693.dat	_Wedge 6 x 4 Inverted Rounded White
	4262.dat	Technic Plate 1 x 6 with Holes
	4263.dat	Technic Plate 1 x 4 with Holes
	4263624.dat	_Technic Axle 5.5 With Stop Dark_Bluish_Gray
	4265.dat	~Moved to 4265b
	4265a.dat	Technic Bush 1/2 Type 1
	4265b.dat	Technic Bush 1/2 Type 2
	4265c.dat	~Moved to 32123
	42688.dat	Technic Flex-System Hose 33L (660LDU)

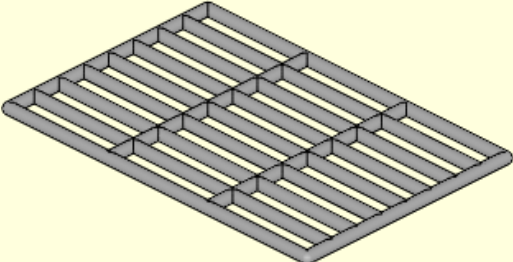











image	file	description
	427.dat	~Moved to 6046
	4270181.dat	_Dish 4 x 4 Inverted Reddish_Brown
	4273.dat	~Moved to 4273b
	4273a.dat	Technic Connector Toggle Joint Toothed With No Slots
	4273b.dat	Technic Connector Toggle Joint Toothed
	4274.dat	Technic Pin 1/2
	4275.dat	~Moved to 4275b
	4275a.dat	Hinge Plate 1 x 2 with 3 Fingers and Solid Studs
	4275b.dat	Hinge Plate 1 x 2 with 3 Fingers and Hollow Studs
	4276.dat	~Moved to 4276b
	4276a.dat	Hinge Plate 1 x 2 with 2 Fingers and Solid Studs
	4276b.dat	Hinge Plate 1 x 2 with 2 Fingers and




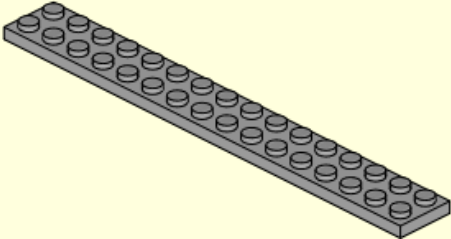
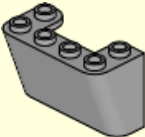



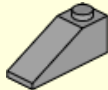


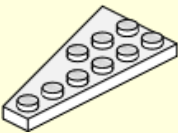
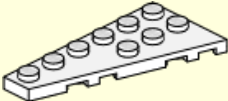


image	file	description
	4277932.dat	Hollow Stud _Bracket 1 x 2 - 2 x 2 Black
	4277933.dat	_Bracket 1 x 2 - 2 x 2 Red
	428.dat	~Moved to 75535
	4282.dat	Plate 2 x 16
	4284.dat	Windscreen 2 x 4 x 2 Inverted
	4285.dat	~Moved to 4285b
	4285a.dat	Dish 6 x 6 Inverted Webbed Type 1
	4285b.dat	Dish 6 x 6 Inverted Webbed Type 2
	4286.dat	Slope Brick 33 3 x 1
	428621.dat	_Slope Brick 33 3 x 1 Red
	4287.dat	Slope Brick 33 3 x 1 Inverted
	4287707.dat	_Wing 3 x 6 Right White
	4287708.dat	_Wing 3 x 6 Left White
	4288.dat	Tyre Balloon
	4288960.dat	_Tail 2 x 3 x 2 Fin White

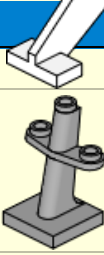

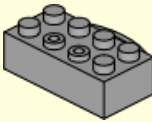
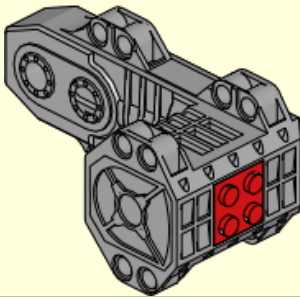
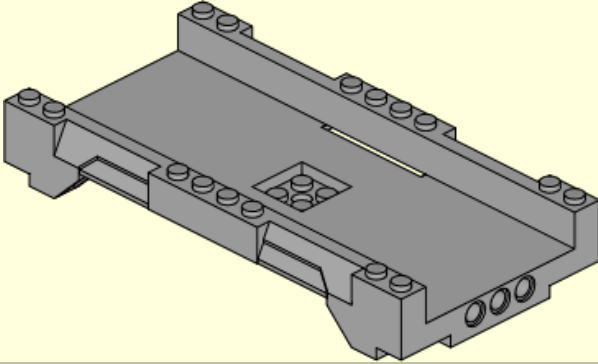
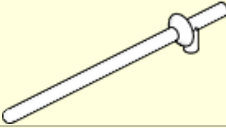





image	file	description
	4289.dat	Boat Mast 2 x 2
	4289538.dat	_Bar 1.5L with Clip Black
	429.dat	~Train Brick 2 x 4 Holder for Sliding Wheel Brick Top Type 2
	42908.dat	Electric RC Race Buggy Motor (Complete)
	42936.dat	Car Track 16 x 8 x 2 Straight
	4294998.dat	_Minifig Lance White
	4296152.dat	_Hinge Control Stick and Base (Complete) Black/Blue
	4297014a.dat	Sticker 2.2 x 3.7 Oval with Batman Logo Yellow/Black
	4297014b.dat	Sticker 1.6 x 1.6 with Black "BANG!" on White/Red Background
	4297014c.dat	Sticker Tail with Red "J" on White Left
	4297014d.dat	Sticker Tail with Red "J" on White Right




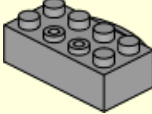
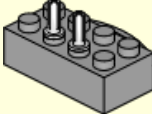
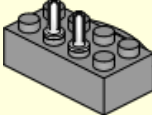
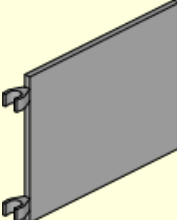
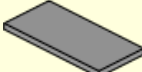

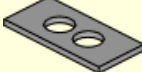
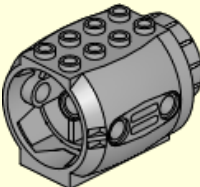

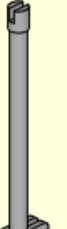
image	file	description
	4297014e.dat	Sticker 2.6 x 1.6 with Dark Green Cover and Green Bolts
	4297014f.dat	Sticker 2.5 x 3.6 with Joker Face
	4298609.dat	_Minifig Helmet Modern White
	429c01.dat	Train Brick 2 x 4 Holder for Sliding Wheel Brick (Complete)
	429c02.dat	Electric Train 12V Brick 2 x 4 Type 2 (Complete)
	429c03.dat	Electric Train 12V Brick 2 x 4 Type 2 (Pushed In Contacts)
	43.dat	~Moved to 2525
	430.dat	~Train Brick 2 x 4 Holder Bottom Solid
	43093.dat	Technic Axle Pin with Friction
	431.dat	~Train Brick 2 x 4 Holder Bottom for Power Pickup
	43121.dat	Plane Jet Engine 4 x 5 x 3
	4315.dat	Hinge Plate 1 x 4 with Car Roof Holder
	4318.dat	Boat Mast Hinged with 2 Fingers on Both Sides

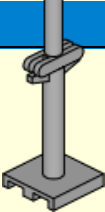
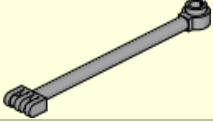

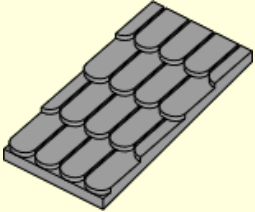
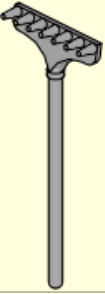

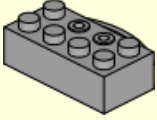



image	file	description
		
	4319.dat	Hinge Bar 8 with Split Bar Holder
	432.dat	~Moved to 6126
	4323.dat	Fabuland Roof Slope without Top Hole
	4324.dat	Fabuland Rake
	4328.dat	Minifig Pipe Wrench (Needs Work)
	433.dat	~Train Brick 2 x 4 Holder for Sliding Wheel Brick Top Type 1
	4332.dat	Minifig Broom
	4337.dat	Minifig Ladle
	43374.dat	Minifig Basketball Net for Hoop

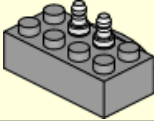
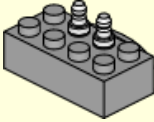
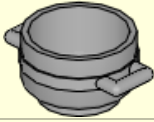


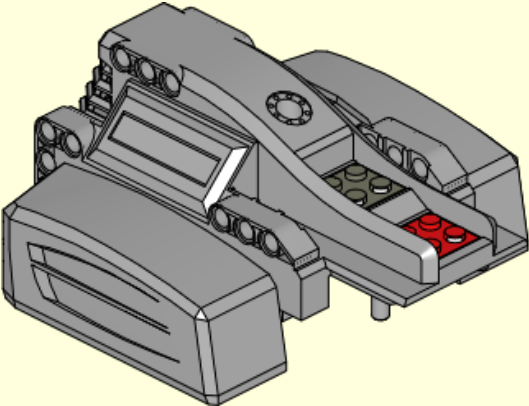
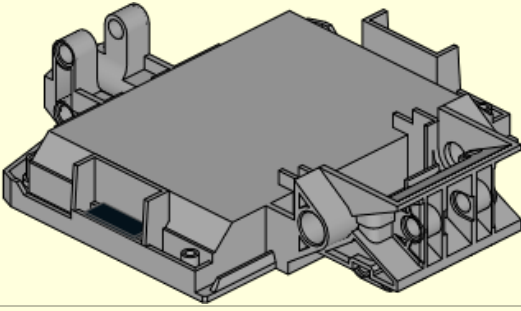
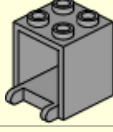
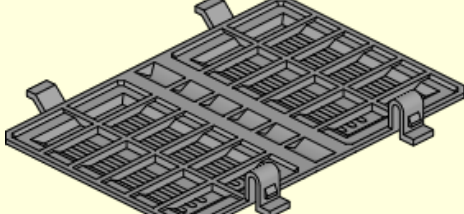
image	file	description
	433c01.dat	Electric Train 12V Brick 2 x 4 Type 1 (Complete)
	433c02.dat	Electric Train 12V Brick 2 x 4 Type 1 (Pushed In Contacts)
	4341.dat	Minifig Cauldron
	4342.dat	Minifig Food French Bread
	4344.dat	~Glass for Door 1 x 4 x 5
	43446.dat	~Electric RC Race Buggy Battery Top
	43447.dat	~Electric RC Race Buggy Battery Base
	4345.dat	~Moved to 4345b
	43457.dat	~Electric RC Race Buggy Battery Lid

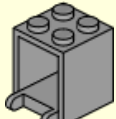
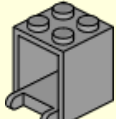
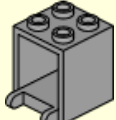
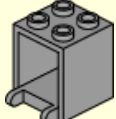

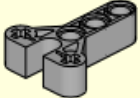
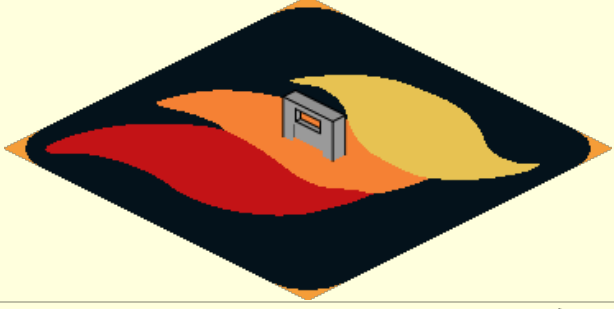

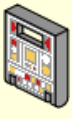
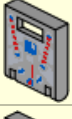


image	file	description
	4345a.dat	Container Box 2 x 2 x 2 with Solid Studs
	4345ap03.dat	Container Box 2 x 2 x 2 Solid Studs with Mailbox Pattern
	4345b.dat	Container Box 2 x 2 x 2 with Hollow Studs
	4345bp03.dat	Container Box 2 x 2 x 2 Hollow Studs with Mailbox Pattern
	4346.dat	Container Box 2 x 2 x 2 Door with Slot
	43464.dat	Technic Beam 4 x 3 Liftarm Triangle
	4346p01.dat	Container Box 2 x 2 x 2 Door with Slot and Fire Logo Pattern
	4346p03.dat	Container Box 2 x 2 x 2 Door with Slot and Mailbox Pattern
	4346p60.dat	Container Box 2 x 2 x 2 Door with Slot with Controls Pattern
	4346p61.dat	Container Box 2 x 2 x 2 Door with Slot and Spyrius Pattern
	4346p68.dat	Container Box 2 x 2 x 2 Door with Slot and MTron Pattern
	4346ps1.dat	Container Box 2 x 2 x 2 Door with Slot and SW Rebel Pattern

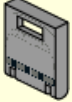
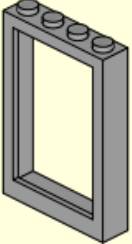
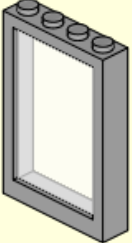

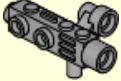



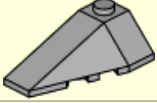
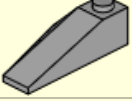
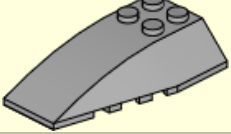
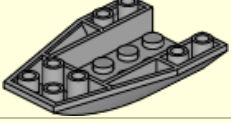
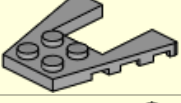
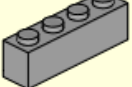
image	file	description
	4346ps2.dat	Container Box 2 x 2 x 2 Door with Slot and Sith Pattern
	4347.dat	~Window 1 x 4 x 5 with Fixed Glass - Frame
	4347c01.dat	Window 1 x 4 x 5 with Fixed Glass (Complete)
	4349.dat	Minifig Loudhailer
	4360.dat	Minifig Camera with Side Sight
	43702.dat	Minifig Basketball
	43702p01.dat	Minifig Basketball with Black Spokes Pattern
	43708.dat	Slope Brick 18 4 x 4 Corner
	43710.dat	Slope Brick 2 x 4 Triple Left
	43711.dat	Slope Brick 2 x 4 Triple Right
	43712.dat	Wedge 6 x 4 Triple Curved
	43713.dat	Wedge 6 x 4 Triple Curved Inverted
	43719.dat	Wing 4 x 4 with 2 x 2 Cutout
	43720.dat	Wedge 4 x 2 Sloped Right

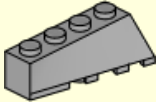








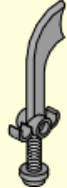



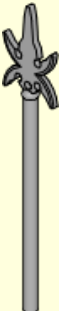
image	file	description
	43721.dat	Wedge 4 x 2 Sloped Left
	43722.dat	Wing 2 x 3 Right
	43723.dat	Wing 2 x 3 Left
	43744.dat	Animal Phoenix
	43745.dat	Minifig Head Elf
	43745p01.dat	Minifig Head Elf with Green Eyes Pattern
	43755.dat	Tile 1 x 1 with Spider Pattern
	43822a.dat	~Moved to 4174735a
	43857.dat	Technic Beam 2
	43887.dat	Minifig Sword Scimitar
	43888.dat	Brick 1 x 1 x 6 Round with Square Base
	43892.dat	Animal Tail
	43898.dat	Dish 3 x 3 Inverted
	43899.dat	Minifig Spear with Four Side Blades

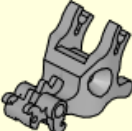

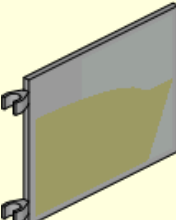

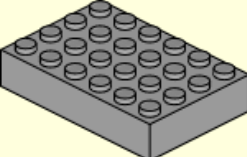
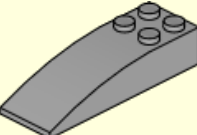
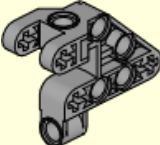
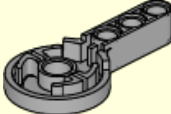
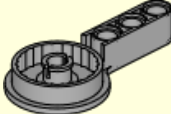
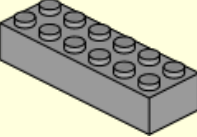

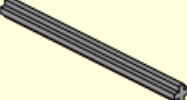
image	file	description
	43900.dat	Animal Dragon Head Oriental
	43p01.dat	~Moved to 2525p31
	43ps1.dat	~Moved to 2525ps1
	44.dat	~Moved to 32126
	44042.dat	Brick 4 x 6
	44126.dat	Slope Brick Curved 6 x 2
	44135.dat	Technic Bionicle Rahkshi Lower Torso Section
	44224.dat	Technic Beam 3 with Rotation Joint 3 Socket
	44225.dat	Technic Beam 3 with Rotation Joint 3 Pin
	44237.dat	Brick 2 x 6
	4424.dat	Barrel 4 & 1/2 x 4 & 1/2
	44294.dat	Technic Axle 7

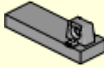


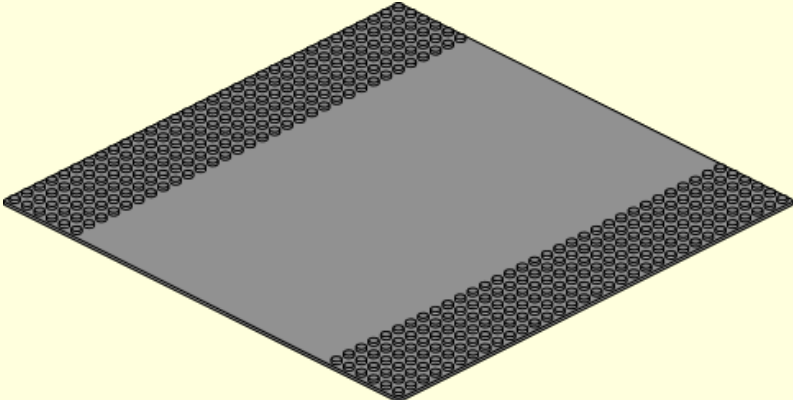
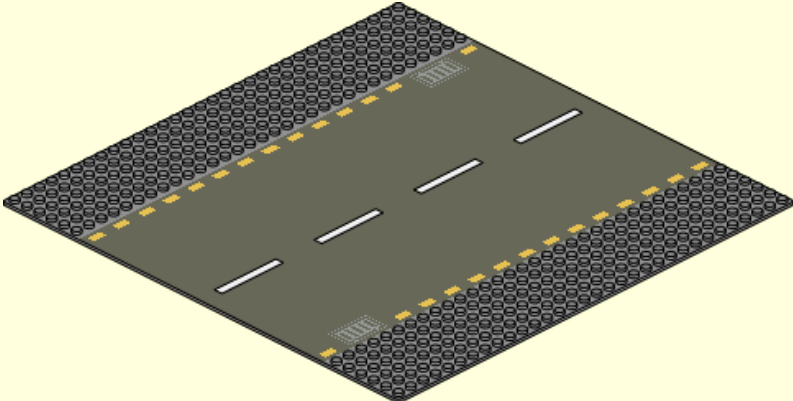
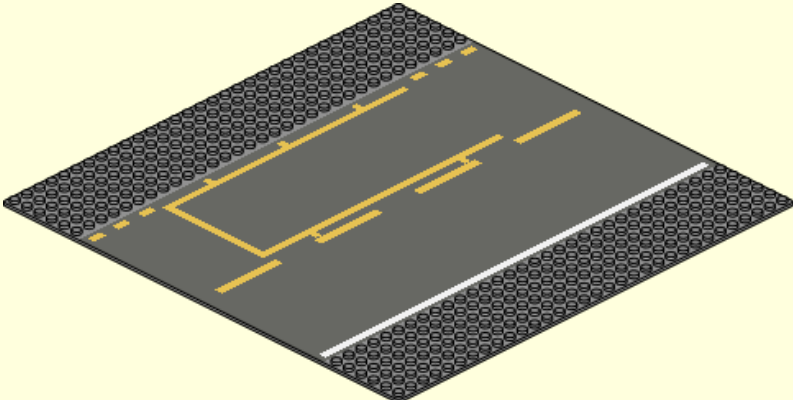
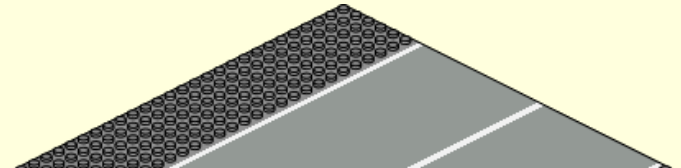
image	file	description
	44300.dat	Hinge Tile 1 x 3 Locking with Single Finger on Top
	44301.dat	Hinge Plate 1 x 2 Locking with Single Finger on End Vertical
	44302.dat	Hinge Plate 1 x 2 Locking with Dual Finger on End Vertical
	44336.dat	Baseplate 32 x 32 Road 6-Stud Straight
	44336p01.dat	Baseplate 32 x 32 Road 6-Stud Straight with Road Pattern
	44336p02.dat	Baseplate 32 x 32 Road 6-Stud Straight with Pit Stop Pattern
	44336p03.dat	Baseplate 32 x 32 Road 6-Stud Straight with Runway Pattern

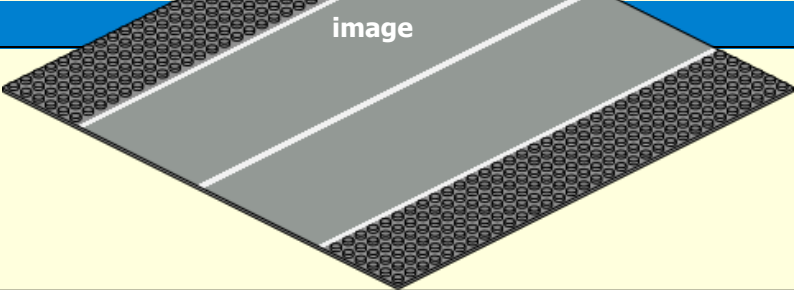
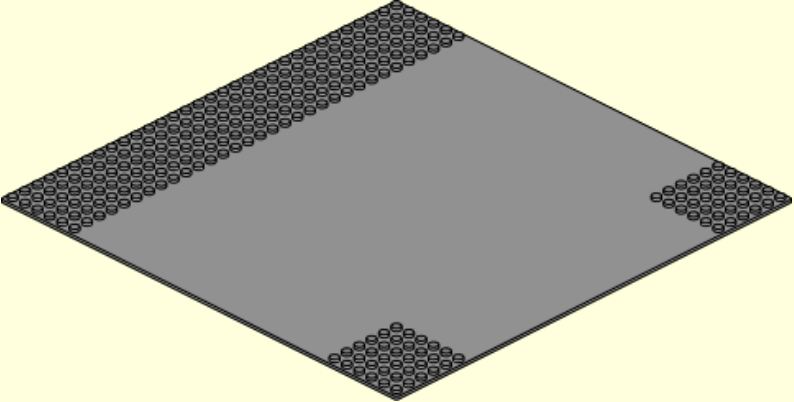
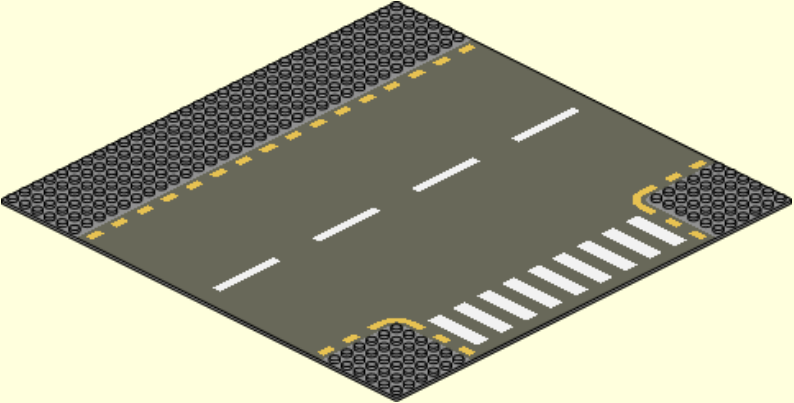
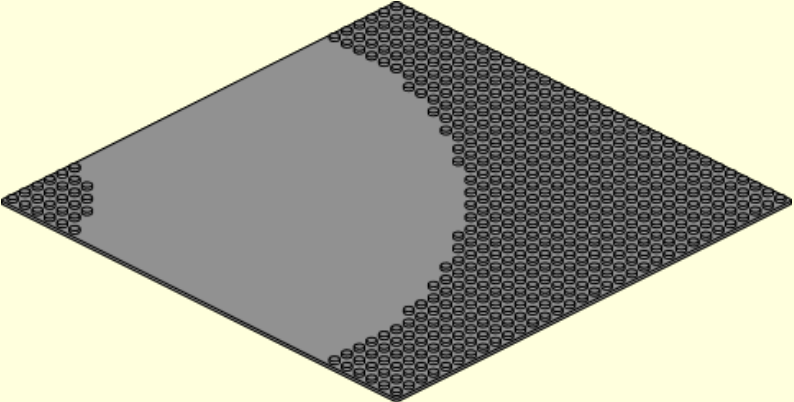
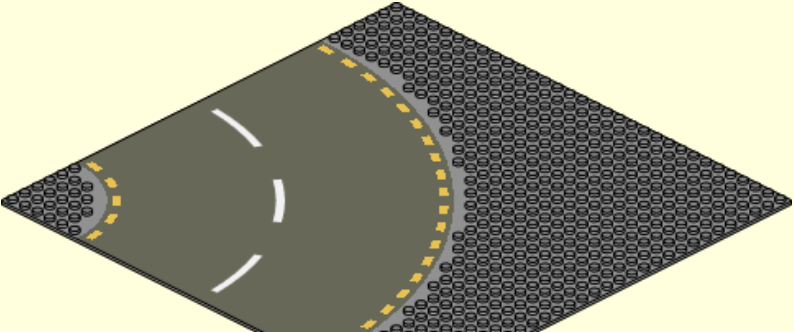
image	file	description
		
	44341.dat	Baseplate 32 x 32 Road 6-Stud T-Junction
	44341p01.dat	Baseplate 32 x 32 Road 6-Stud T-Junction with Pattern
	44342.dat	Baseplate 32 x 32 Road 6-Stud Curve
	44342p01.dat	Baseplate 32 x 32 Road 6-Stud Curve with Pattern

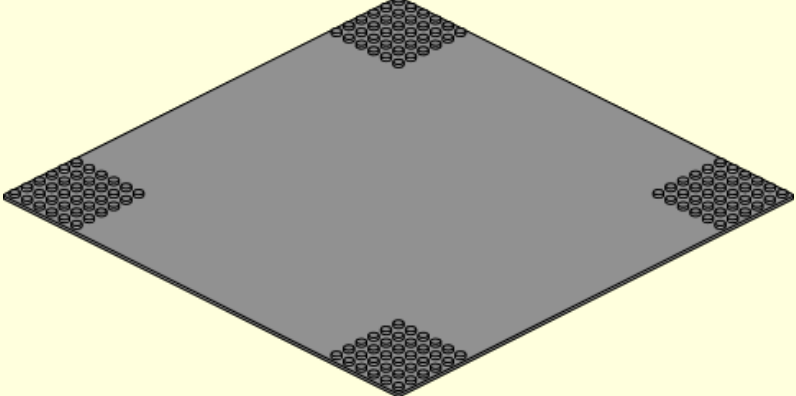
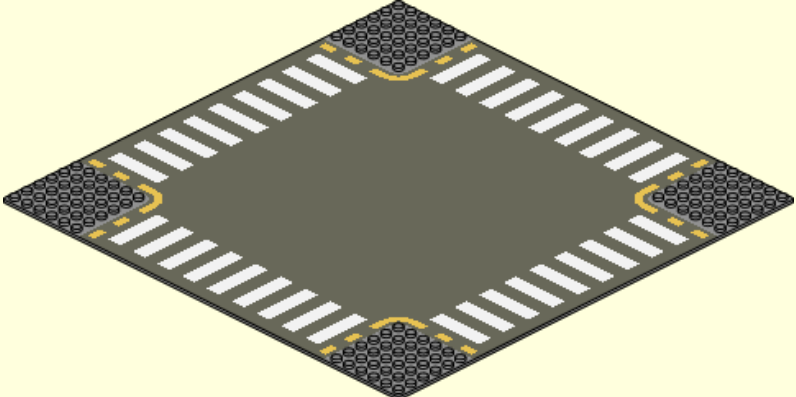
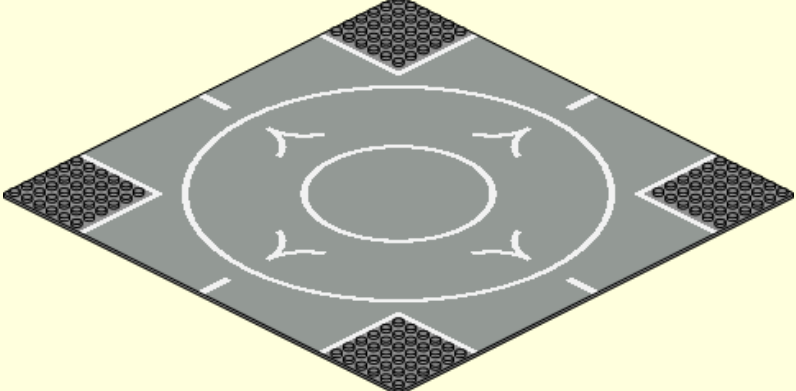
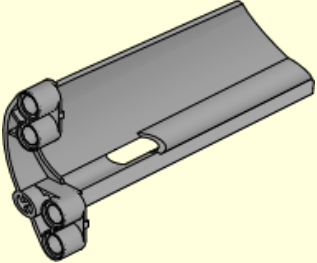
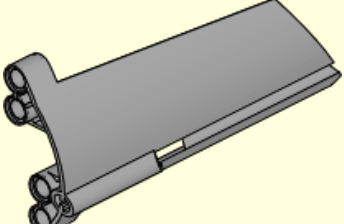
image	file	description
	44343.dat	Baseplate 32 x 32 Road 6-Stud Crossroads
	44343p01.dat	Baseplate 32 x 32 Road 6-Stud Crossroad with Pattern
	44343p02.dat	Baseplate 32 x 32 Road 6-Stud Crossroads with Runway Pattern
	44350.dat	Technic Panel Fairing #20
	44351.dat	Technic Panel Fairing #21


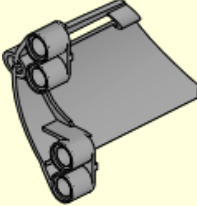
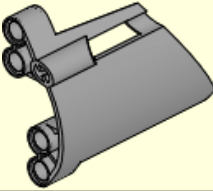
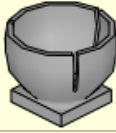

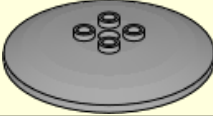

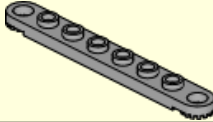
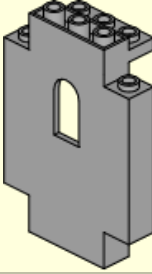

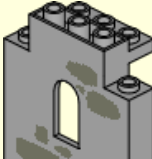
image	file	description
 	44352.dat	Technic Panel Fairing #22
	44353.dat	Technic Panel Fairing #23
	44358.dat	Plate 2 x 2 with Hemispherical Socket 3 x 3 x 2
	44374.dat	Technic Rotor 3 Blade x 0.5 Liftarm
	44375.dat	Dish 6 x 6 Inverted
	4438.dat	Fabuland Axe
	4442.dat	Technic Plate 1 x 8 with Holes
	4444.dat	Panel 2 x 5 x 6 Wall
	4444p01.dat	Panel 2 x 5 x 6 Wall with Dark Gray Stones Pattern
	4444p02.dat	Panel 2 x 5 x 6 Wall with Dark Gray Scattered Stones Pattern

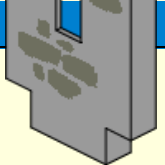
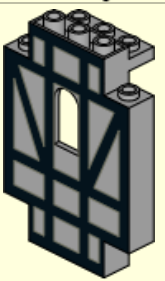
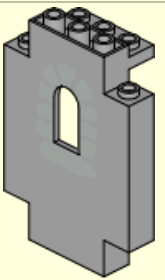
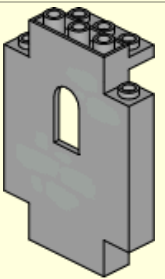
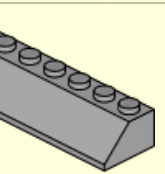
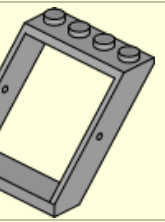

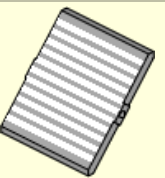

image	file	description
		
	4444p03.dat	Panel 2 x 5 x 6 Wall with Black Half-Timber Pattern
	4444p04.dat	Panel 2 x 5 x 6 Wall with Light Gray Window Stones Pattern
	4444p05.dat	Panel 2 x 5 x 6 Wall with Light Gray Scattered Stones Pattern
	4445.dat	Slope Brick 45 2 x 8
	4447.dat	Window 4 x 4 x 3 Roof
	4448.dat	Glass for Window 4 x 4 x 3 Roof
	4448d01.dat	Glass for Window 4 x 4 x 3 Roof with White Stripes Sticker
	4448p01.dat	~Moved to 4448d01





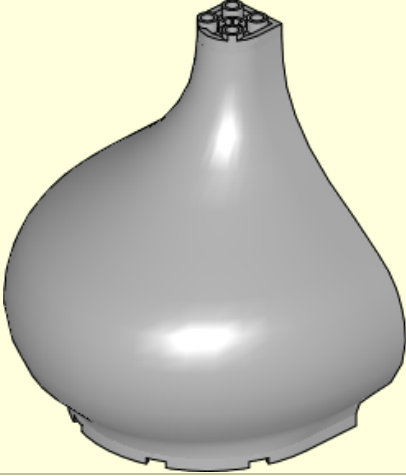
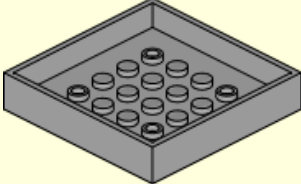
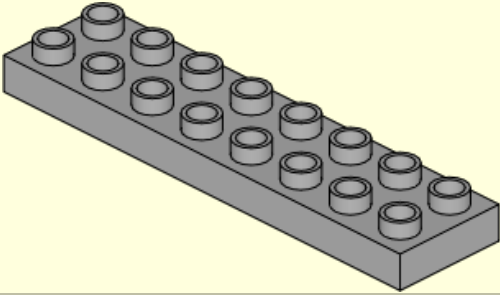


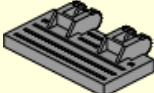
image	file	description
		
	4449.dat	Minifig Suitcase
	4449c01.dat	Minifig Suitcase Open (Shortcut)
	445.dat	~Moved to 3193a
	44511.dat	Roof Piece 8 x 12 x 10 Half Onion Dome
	4452.dat	Container Box 6 x 6
	44524.dat	Duplo Plate 2 x 8
	44567.dat	Hinge Plate 1 x 2 Locking with Single Finger On Side Vertical
	44568.dat	Hinge Plate 1 x 4 Locking with Two Single Fingers on Side
	44569.dat	Hinge Tile 2 x 4 with Ribs Locking

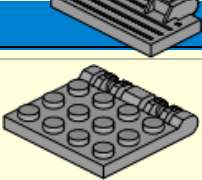


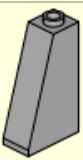
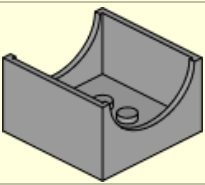
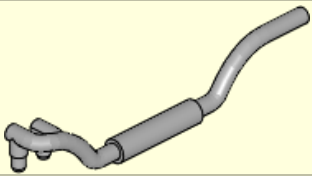
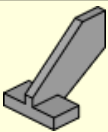
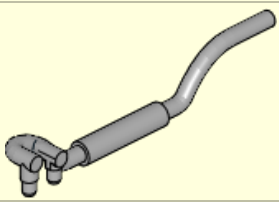


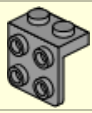
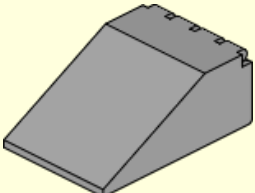
image	file	description
	44570.dat	Hinge Car Roof 4 x 4 Locking
	4459.dat	Technic Pin with Friction
	446.dat	~Moved to 3192a
	4460.dat	Slope Brick 75 2 x 1 x 3
	4461.dat	Container Box 4 x 4 x 2 with Hollowed-Out Semi-Circle
	4466.dat	Exhaust Pipe Twin Inlet 11L Left
	44661.dat	Tail 2 x 3 x 2 Fin
	4467.dat	Exhaust Pipe Twin Inlet 11L Right
	44675.dat	Slope Brick Curved Top 2 x 2 x 1 with Dimples
	44676.dat	Flag 2 x 2 Trapezoid
	44728.dat	Bracket 1 x 2 - 2 x 2
	4474.dat	Windscreen 6 x 4 x 2 Canopy

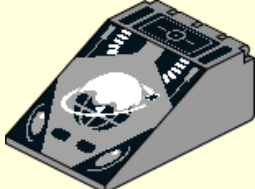
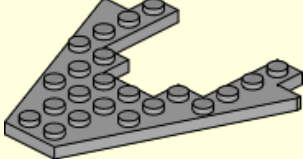
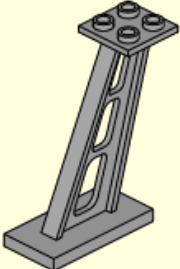
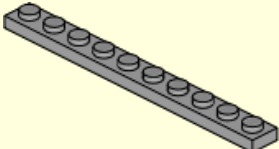
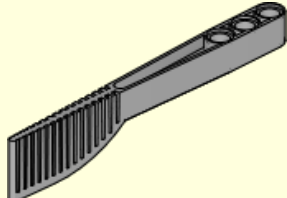
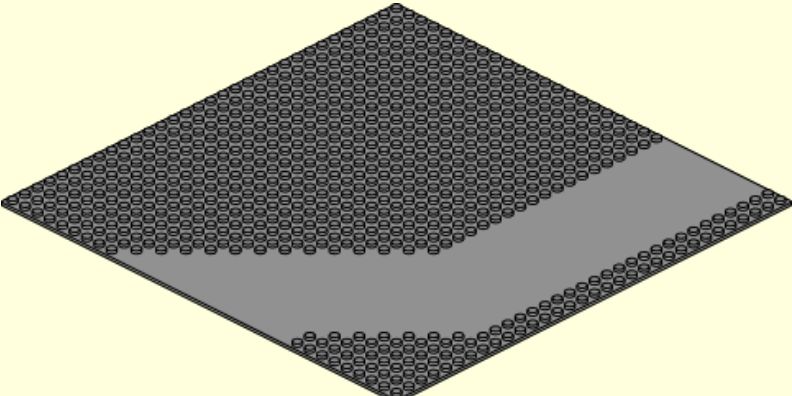
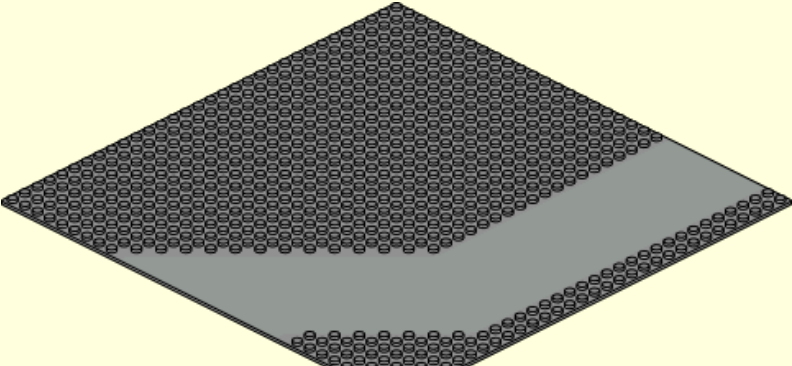
image	file	description
	4474p61.dat	Windscreen 6 x 4 x 2 Canopy with Ice Planet Logo Pattern
	4475.dat	Wing 8 x 8 with 4 x 4 Cutout
	4476.dat	Support 2 x 4 x 5 Stanchion Inclined
	4477.dat	Plate 1 x 10
	44775.dat	Technic Track System Gate 11 x 2 with Three Holes and Paddle
	4478.dat	Baseplate 32 x 32 Road 9-Stud Driveway
	4478p01.dat	Baseplate 32 x 32 Road 9-Stud Driveway with Grey Pattern

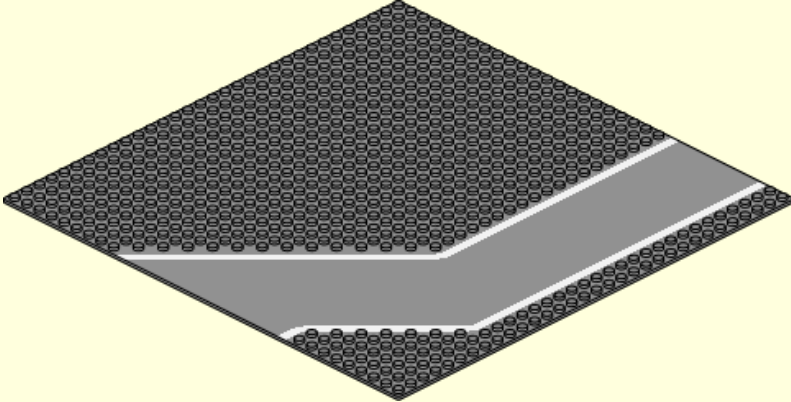
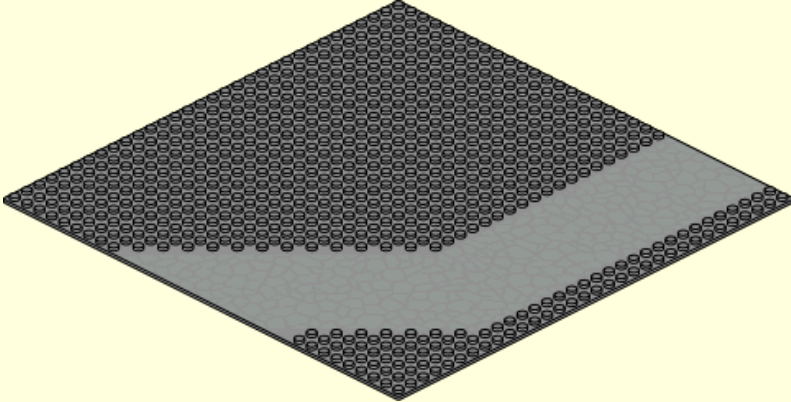
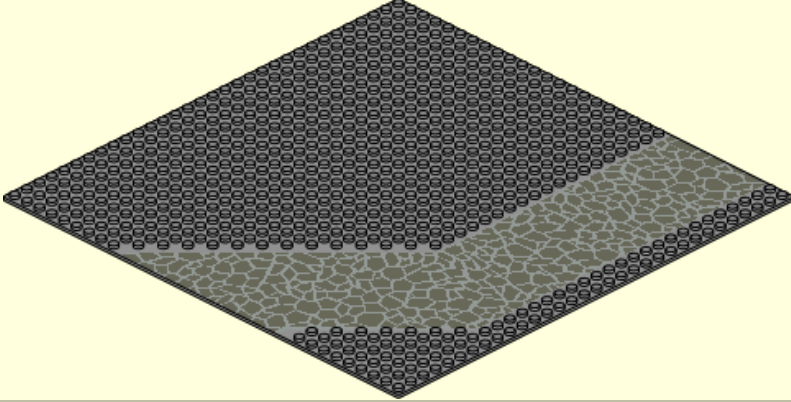
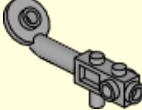

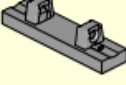

image	file	description
	4478p02.dat	Baseplate 32 x 32 Road 9-Stud Driveway with White Lines Pattern
	4478p03.dat	Baseplate 32 x 32 Road 9-Stud Driveway with Grey Crazy Paving
	4478p04.dat	Baseplate 32 x 32 Road 9-Stud Driveway with DkGrey Crazy Paving
	4479.dat	Minifig Metal Detector
	44809.dat	Technic Cross Block 2 x 2 Bent 90 (Pin/Pin/Pin)
	44822.dat	Hinge Tile 1 x 4 Locking with 2 Single Fingers on Top
	4483.dat	Motorcycle Windshield





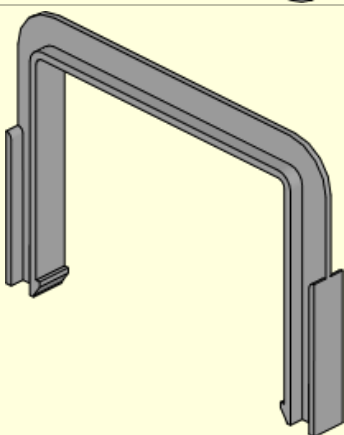
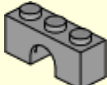
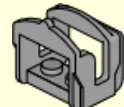
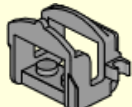




image	file	description
	4485.dat	Minifig Cap
	44852.dat	Technic Axle Joiner Rectangular with Spring (Complete)
	4488.dat	Plate 2 x 2 with Wheel Holder
	4489.dat	Castle Wagon Wheel Large
	449.dat	~Storage Box 24 x 40 Handle
	4490.dat	Arch 1 x 3
	4491a.dat	Animal Horse Saddle with One Clip
	4491b.dat	Animal Horse Saddle with Two Clips
	4492.dat	Animal Horse Head
	4492p01.dat	Animal Horse Head with Brown/White Tack Pattern
	4492p02.dat	Animal Horse Head with Brown/Black Tack Pattern
	4492p03.dat	Animal Horse Head with Red Tack Pattern


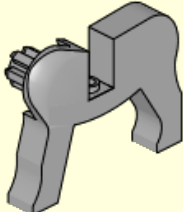
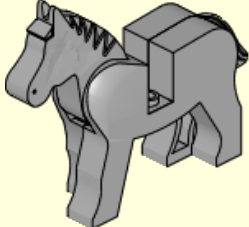
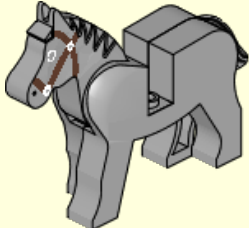
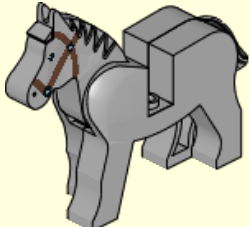
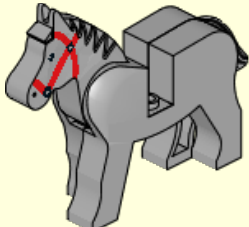
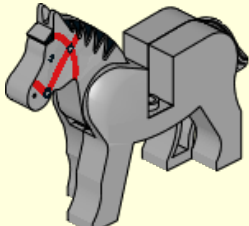
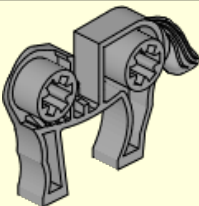
image	file	description
	4492p04.dat	Animal Horse Head with Red Tack and Black Mane Pattern
	4493.dat	Animal Horse Body Left
	4493c00.dat	Animal Horse (Complete)
	4493c01.dat	Animal Horse with Brown/White Tack Pattern (Complete)
	4493c02.dat	Animal Horse with Brown/Black Tack Pattern (Complete)
	4493c03.dat	Animal Horse with Red Tack Pattern (Complete)
	4493c04.dat	Animal Horse with Red Tack and Black Mane Pattern (Complete)
	4494.dat	Animal Horse Body Right

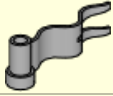

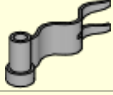













image	file	description
	4495.dat	~Moved to 4495a
	449521.dat	_Flag 4 x 1 Red
	4495a.dat	Flag 4 x 1 with First Wave Left
	4495b.dat	Flag 4 x 1 with First Wave Right
	4496.dat	Minifig Pitchfork
	4497.dat	Minifig Spear
	4497943.dat	_Cylinder Domed 1 x 1 x 1.667 with Bar Trans Red
	4497946.dat	_Technic Connector Block 3 x 3 Triangular with Axlehole Black
	4498.dat	Minifig Arrow Quiver
	4499.dat	Minifig Bow with Arrow
	45.dat	Tile 1 x 2 with Ball
	450.dat	~Wheel 6.4 x 8
	4501575.dat	_Brick 4 x 4 Round with Holes Yellow
	4502a.dat	~Moved to 87693
	4502b.dat	~Moved to 87692
	4502c.dat	~Moved to 87694


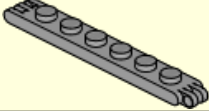


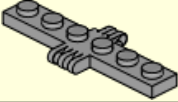
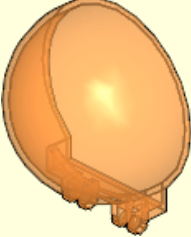



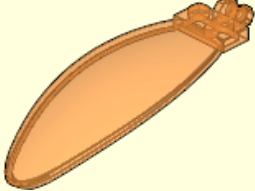
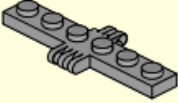

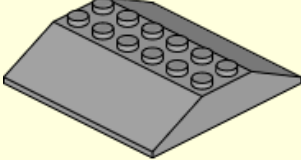

image	file	description
	4503.dat	Minifig Helmet Castle with Fixed Face Grille
	4504.dat	Hinge Plate 1 x 6 with 2 and 3 Fingers On Ends
	4504369.dat	_Slope Brick 31 1 x 1 x 0.667 White
	4504371.dat	_Slope Brick 31 1 x 1 x 0.667 Orange
	4505.dat	~Moved to 4507
	4505156.dat	_Windscreen 6 x 6 x 3 Dome Hinge Locking Trans_Orange
	4505a.dat	Minifig Hood Medieval Cowl
	4506480.dat	_Cylinder Domed 1 x 1 x 1.667 with Bar Trans Light Blue
	4506697.dat	_Technic Angle Connector #5 (112.5 degree) White
	4506847.dat	_Windscreen 9 x 3 x 1.667 Bubble Canopy Trans_Orange
	4507.dat	Hinge Plate 1 x 6 with 2 and 3 Fingers On Sides
	4508.dat	~Turntable 2 x 2 Plate Base with Hinge
	4509.dat	Slope Brick 33 6 x 6 Double
	451.dat	Tyre 3/100 x 8 Double Smooth

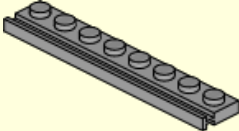


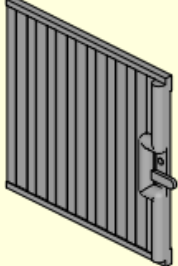
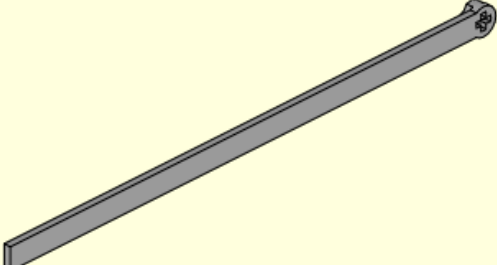
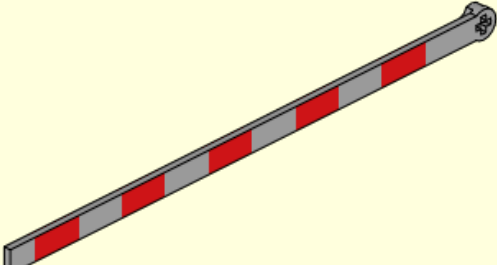
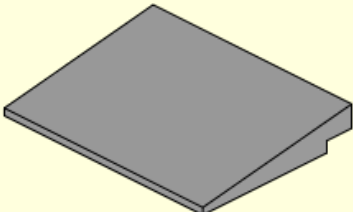
image	file	description
	4510.dat	Plate 1 x 8 with Door Rail
	45106.dat	Animal Dragon Tail Oriental
	45106p01.dat	Animal Dragon Tail Oriental with Metallic Gold Pattern
	4511.dat	Door 6 & 1/2 x 5 Sliding with Vertical Lines
	4512.dat	Train Level Crossing Gate Type 2
	4512p01.dat	Train Level Crossing Gate Type 2 with Red Stripes Pattern
	4515.dat	Slope Brick 10 6 x 8

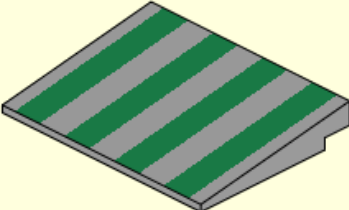
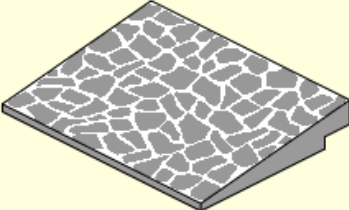
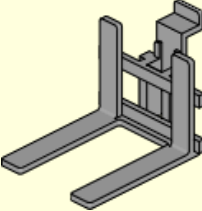

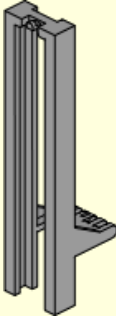
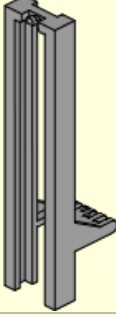
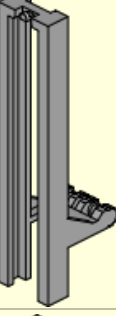

image	file	description
	4515p02.dat	Slope Brick 10 6 x 8 with Green Stripes Pattern
	4515p03.dat	Slope Brick 10 6 x 8 with Slate Roof Pattern
	4517.dat	Forklift Forks 4 x 6 (Needs Work)
	4517925.dat	_Plate 1 x 1 with Clip Horizontal Black
	4518.dat	~Moved to 4518a
	4518a.dat	Forklift Rails 2 x 3 x 7.667 Non-locking with 6 Fingers
	4518b.dat	Forklift Rails 2 x 3 x 7.667 Locking with 4 Fingers
	4519.dat	Technic Axle 3


















image	file	description
	4520782.dat	_Slope Brick Curved 4 x 1 Red
	4521703a.dat	Sticker 1.1 x 8 with "CARWASH" and Red/Green Stripes
	4521703b.dat	Sticker 1.1 x 8 with "SERVICESTATION" and Red/Green Stripes
	4521703c.dat	Sticker 2.4 x 3.4 Oval with Octan Logo/Text
	4521703e.dat	Sticker 1.9 x 1.9 Round with Octan Logo/Text
	4521703f.dat	Sticker 0.8 x 1.8 with Black "CA 0108" and Border
	4521703g.dat	Sticker 0.8 x 1.8 with Black "LE 0158" and Border
	4521703o.dat	Sticker 1.7 x 1.7 with Dark_Red "C"
	4521703p.dat	Sticker 1.7 x 1.7 with Dark_Red "I"
	4521703q.dat	Sticker 1.7 x 1.7 with Dark_Red "N"
	4521703r.dat	Sticker 1.7 x 1.7 with Dark_Red "E"
	4521703s.dat	Sticker 1.7 x 1.7 with Dark_Red "M"
	4521703t.dat	Sticker 1.7 x 1.7 with Dark_Red "A"
	4521703u.dat	Sticker 3.5 x 3.9 with "LEGO TOWN" Map
	4521852.dat	_Brick 2 x 2 with Curved Top and 2 Studs on Top Red
	4522.dat	Minifig Tool Mallet
	4523.dat	Minifig Container D-Basket




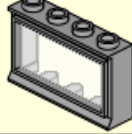

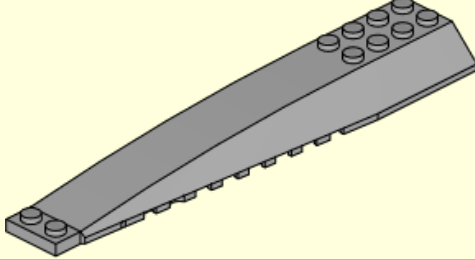

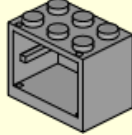

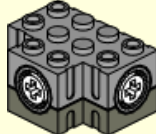
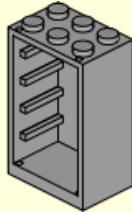

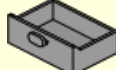

image	file	description
	4524.dat	Minifig Cape
	4528.dat	Minifig Frypan
	4529.dat	Minifig Saucepan
	453.dat	~Moved to 453cc01
	4530.dat	Minifig Hair Shoulder Length
	45301.dat	Wedge 4 x 16 Triple Curved
	4531.dat	Hinge Tile 1 x 2 with 2 Fingers
	4532.dat	Container Cupboard 2 x 3 x 2
	4533.dat	Container Cupboard 2 x 3 x 2 Door
	45337.dat	Technic Gearbox 3 x 4 x 1.667 T-shaped (Complete)
	4534.dat	Container Cupboard 2 x 3 x 4
	4535.dat	Container Cupboard 2 x 3 x 4 Door
	4536.dat	Container Cupboard 2 x 3 x 2 Drawer
	45360.dat	~Technic Gearbox 3 x 3 x 1.667 Corner Base

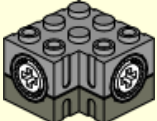
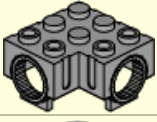

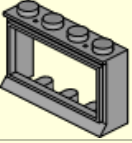
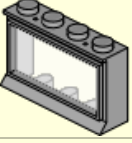
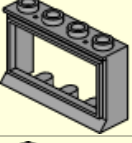
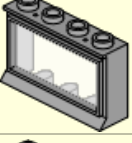
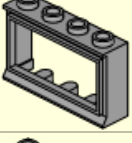
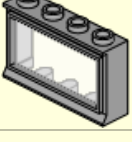
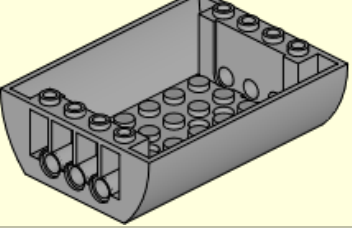
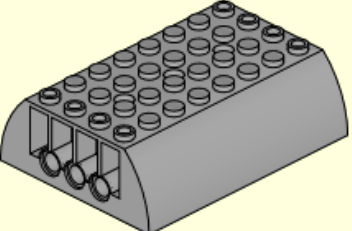
image	file	description
	45360c01.dat	Technic Gearbox 3 x 3 x 1.667 Corner (Complete)
	45361.dat	~Technic Gearbox 3 x 3 x 1.667 Corner Top
	4539364.dat	_Die 6 Sided 2 x 2 x 2 Red/Black
	453a.dat	~Window 1 x 4 x 2 Classic with Solid Studs
	453ac01.dat	Window 1 x 4 x 2 Classic with Solid Studs (Complete)
	453b.dat	~Window 1 x 4 x 2 Classic with Long Sill
	453bc01.dat	Window 1 x 4 x 2 Classic with Long Sill (Complete)
	453c.dat	~Window 1 x 4 x 2 Classic with Short Sill
	453cc01.dat	Window 1 x 4 x 2 Classic with Short Sill (Complete)
	45410.dat	Slope Brick Curved 6 x 8 x 2 Inverted Double
	45411.dat	Slope Brick Curved 6 x 8 x 2 Double






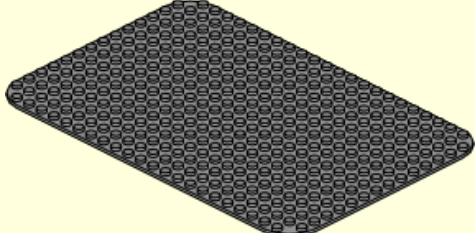

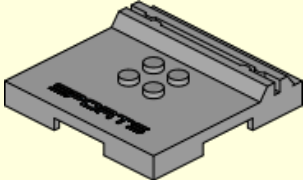
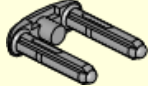

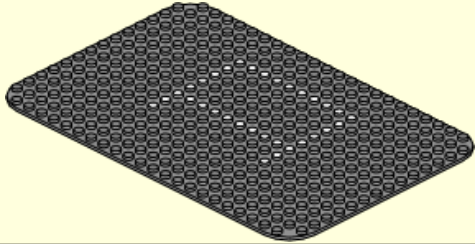
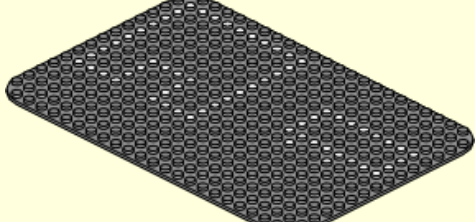
image	file	description
	45417.dat	Brick 2 x 2 Corner Round
	4542422a.dat	Sticker 1.8 x 1.8 Round with Roadsign "50"
	4542422b.dat	Sticker Roadsign Triangle with Traffic Light Pattern
	4542422c.dat	Sticker 1.8 x 1.8 with Roadsign Minifig Crosswalk
	4544143.dat	_Train Wheel Large Traction Band Red
	455.dat	Baseplate 16 x 24 with Rounded Corners
	4550640a.dat	Sticker 2 x 2 Round with Radioactive Hazard Trefoil
	45522.dat	Tile 6 x 6 x 2/3 with 4 Studs and Card-holder - "SPORTS"
	45575.dat	Technic Double Flexible Fixing Pin
	45590.dat	Technic Axle Joiner Double Flexible
	455p01.dat	Baseplate 16 x 24 with Rounded Corners with Set 344 Dots Pattern
	455p02.dat	Baseplate 16 x 24 with Rounded Corners with Set 362 Dots Pattern

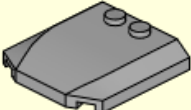
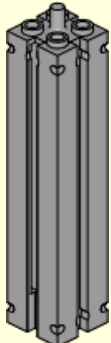
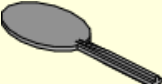

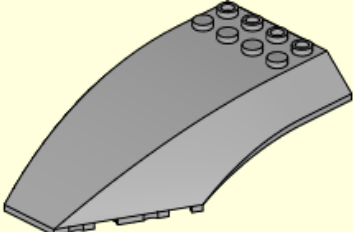

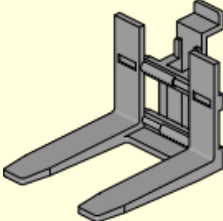


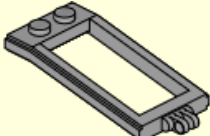

image	file	description
	45677.dat	Wedge 4 x 4 x 2/3 Curved
	45695.dat	Brick 2 x 2 x 8 with Vertical Grooves on All Sides and Peg
	457.dat	Maxifig Tool Oar
	4570481.dat	_Cylinder Domed 1 x 1 x 1.667 with Bar Trans Bright Green
	45705.dat	Windscreen 10 x 6 x 2
	4570662.dat	_Minifig Ring with Triangle with Turtle Pattern Trans Yellow
	45707.dat	Forklift Forks 4 x 7
	45729.dat	Dish 6 x 6 Inverted
	458.dat	Tyre for Train Wheel for Electric Train Motor 12V
	4587.dat	Animal Horse Hitching with Hinge
	4588.dat	Brick 1 x 1 Round with Fins



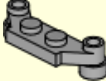
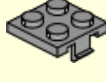

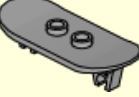




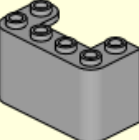

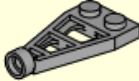
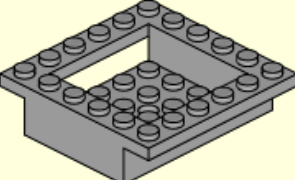
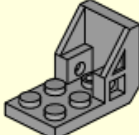


image	file	description
	4589.dat	Cone 1 x 1
	458c01.dat	Tyre for Electric Train 12V Motor Conically Deformed
	4590.dat	Plate 1 x 4 Offset
	45907.dat	~Electric Connector Plate 2 x 2 with Contacts
	4591.dat	Brick 2 x 2 x 2 Round with Fins
	45917.dat	Minifig Skateboard with Two Wheel Clips
	45918.dat	Wheels Skateboard
	4592.dat	Hinge Control Stick Base
	4592c01.dat	Hinge Control Stick and Base (Complete)
	4593.dat	Hinge Control Stick
	4594.dat	Windscreen 2 x 4 x 2 Vertical
	4595.dat	Brick 1 x 2 x 0.667 with Studs on Sides
	4596.dat	Plate 1 x 2 with 3L Extension and Stud Hole
	4597.dat	Cockpit 6 x 6
	4598.dat	Bracket 2 x 3 - 2 x 2
	4599.dat	Tap 1 x 1
	459923.dat	_Tap 1 x 1 Blue

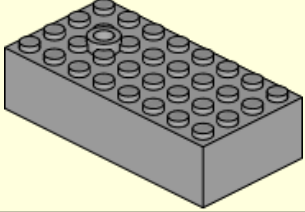
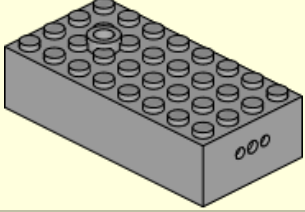


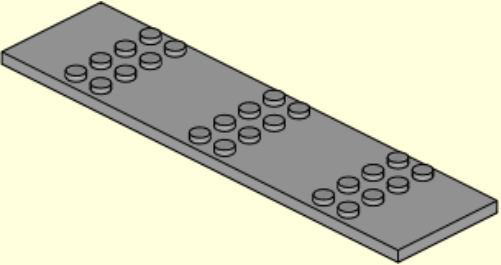
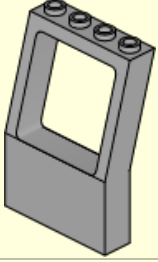

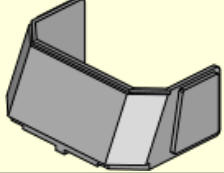
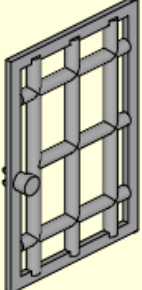
image	file	description
	459a.dat	~Train 12V Actuator 4 x 8 x 1.667 Manual
	459b.dat	~Train 12V Actuator 4 x 8 x 1.667 Electric
	4600.dat	Plate 2 x 2 with Wheels Holder
	4601.dat	~Moved to 4624
	4607.dat	Tile 4 x 16 with 24 studs
	4608.dat	Window 2 x 4 x 5
	461.dat	~Moved to 3688
	46103.dat	Glass for Windscreen 4 x 6 x 4 Cab with Hinge
	4611.dat	Door 6 x 7 Barred

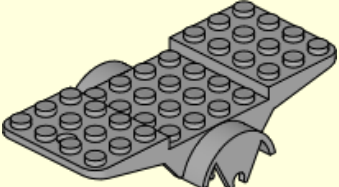
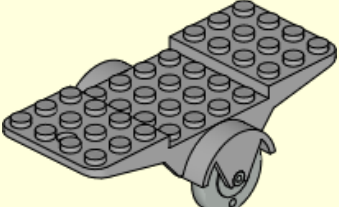


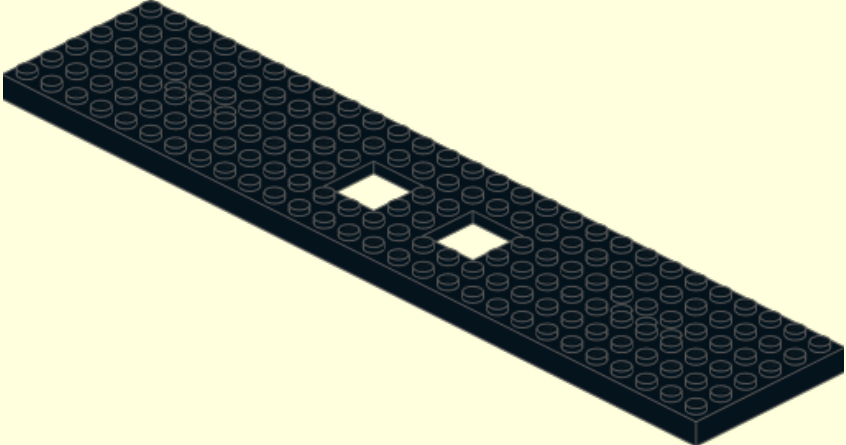



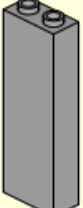
image	file	description
	4613.dat	Vehicle Base 10 x 4 with Two Wheel Holders
	4613c01.dat	Vehicle Base 10 x 4 with Two Wheels Light Gray
	4616559m.dat	Sticker 0.8 x 1.8 with "ML 1928"
	4616559n.dat	Sticker 0.8 x 1.8 with "APM 1904"
	4616992.dat	_Train Base 6 x 28 with 6 Holes and Twin 2 x 2 Cutouts Black
	4617.dat	~Moved to 4617b
	4617a.dat	Propellor 3 Blade 5.5 Diameter with Freestyle Pinhole
	4617b.dat	Propellor 3 Blade 5.5 Diameter with Technic Peghole
	46212.dat	Brick 1 x 2 x 5 without Centre Studs

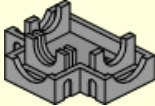
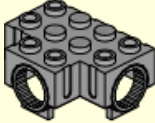

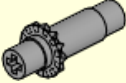



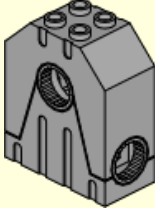
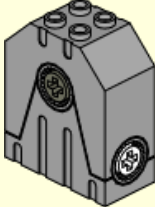

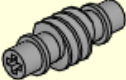



image	file	description
	46217.dat	~Technic Gearbox 3 x 4 x 1.667 T-shaped Base
	46218.dat	~Technic Gearbox 3 x 4 x 1.667 T-shaped Top
	46219.dat	~Technic Gear 12 Tooth Bevel with Single Axle Joiner
	46220.dat	~Technic Gear 12 Tooth Bevel with Double Axle Joiner
	4622303g.dat	Sticker 0.75 x 1.75 with Mercedes-Benz Logo
	4622303r.dat	Sticker 0.75 x 5 with Pneumatic Cylinder / Half Trucks Diagram
	4622303t.dat	Sticker 0.75 x 7.5 with Pneumatic Cylinder and Truck Diagram
	46224.dat	~Technic Gearbox 2 x 4 x 4 Base
	46224c01.dat	Technic Gearbox 2 x 4 x 4 (Complete)
	46225.dat	~Technic Gearbox 2 x 4 x 4 (Axle 1)
	46226.dat	~Technic Gearbox 2 x 4 x 4 (Axle 2)
	46227.dat	~Technic Gear 24 Tooth Double Bevel
	4623.dat	Plate 1 x 2 with Vertical Bar on Long Side and Long Arm
	4623959.dat	_Animal Chicken with Red Comb Pattern White



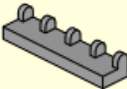
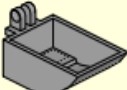
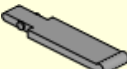

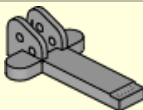
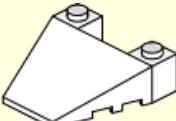
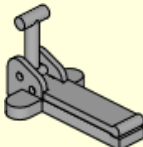
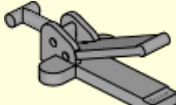


image	file	description
	4624.dat	Wheel Centre Small
	4624282.dat	_Animal Chicken with Red Comb Pattern Dark Tan
	4625.dat	Hinge Tile 1 x 4
	4626.dat	Excavator Bucket 2 x 3
	4627.dat	Jack Lifter
	4628.dat	Jack Handle
	4629.dat	Jack Base
	4629916.dat	_Wedge 4 x 4 with Stud Notches White
	4629down.dat	Jack Assembly - Lowered
	4629up.dat	Jack Assembly - Raised
	46303.dat	Minifig Helmet Skateboard
	46305.dat	Technic Flex-System Hose 40L (800LDU)


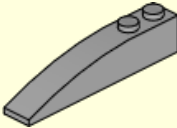
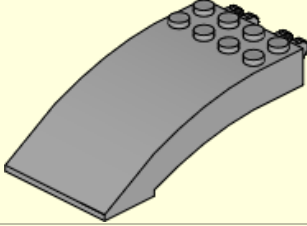





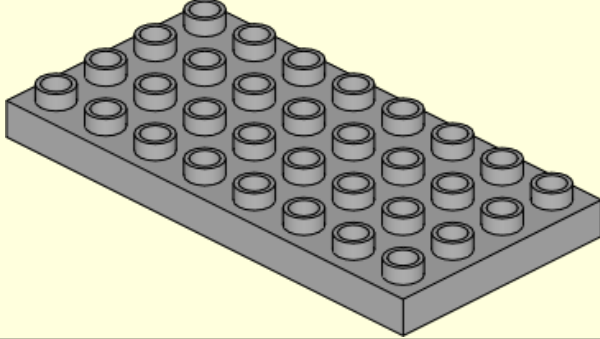
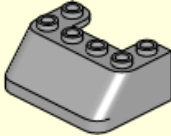

image	file	description
	4633881.dat	_Tile 2 x 2 with Ship Portrait Pattern Dark Tan
	464.dat	~Moved to 42022
	46413.dat	Hinge Brick 4 x 8 x 2 Curved Locking with 2 Dual Fingers
	466a.dat	~Minifig Book Spine
	466b.dat	~Minifig Book Front
	466c.dat	~Minifig Book Back
	466d.dat	~Minifig Book Joint Curved
	466e.dat	~Minifig Book Joint Straight
	4672.dat	Duplo Plate 4 x 8
	4688.dat	~Moved to 4866
	469.dat	~Moved to 30261

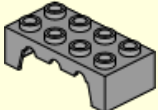
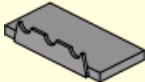
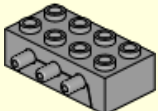
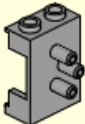
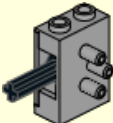
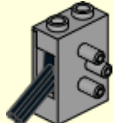
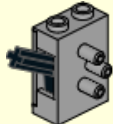




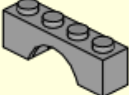

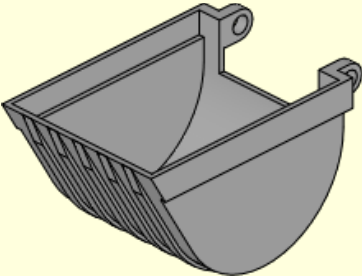
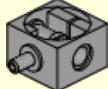
image	file	description
	4691.dat	~Technic Pneumatic Distribution Block 2 x 4 Top
	4692.dat	~Technic Pneumatic Distribution Block 2 x 4 Bottom
	4692c01.dat	Technic Pneumatic Distribution Block 2 x 4 (Complete)
	4694.dat	~Technic Pneumatic Valve Casing
	4694c01.dat	Technic Pneumatic Valve (Complete - Neutral Position)
	4694c02.dat	Technic Pneumatic Valve (Complete - Down Position)
	4694c03.dat	Technic Pneumatic Valve (Complete - Up Position)
	4695.dat	~Technic Pneumatic Valve Lever
	4697a.dat	Technic Pneumatic T-Piece - Type 1
	4697b.dat	Technic Pneumatic T-Piece - Type 2
	4698.dat	Technic Axle Nut
	47.dat	~Moved to 3659
	470.dat	~Moved to 30258
	4700.dat	Technic Excavator Bucket 6 x 9
	4701.dat	~Technic Pneumatic Cylinder 2 x 2 Base Type 1

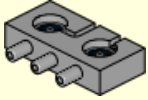
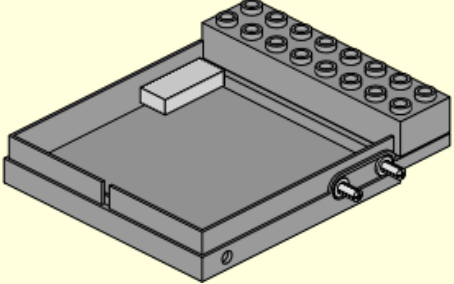
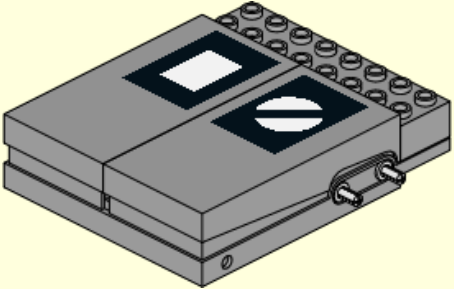
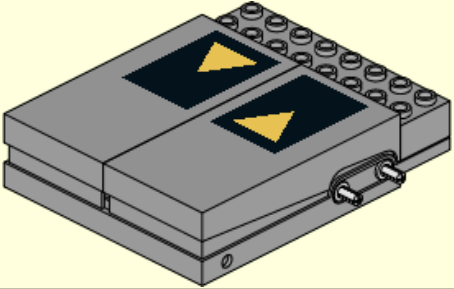
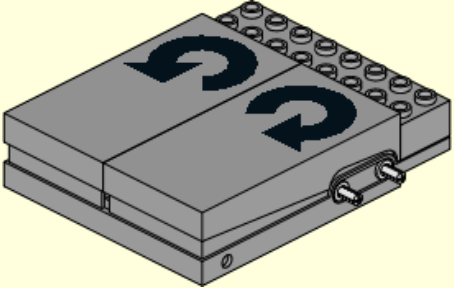



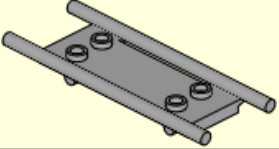

image	file	description
	4706.dat	~Technic Pneumatic Distribution Block 2 x 4 Internals
	4707.dat	~Electric Switch Base with 1 Twin Plug Socket
	4707c01.dat	Electric Switch: Remote Control for Train Point
	4707c02.dat	Electric Switch: Remote Control for Train Decoupler
	4707c03.dat	Electric Switch: Remote Control with Rotating Arrows Pattern
	470p01.dat	~Moved to 30258p01
	471.dat	~Moved to 30127
	4713.dat	~Technic Pneumatic Valve Side Cover
	4714.dat	Stretcher
	4715.dat	Stretcher Wheels

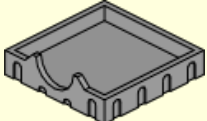
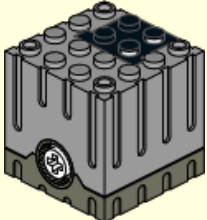
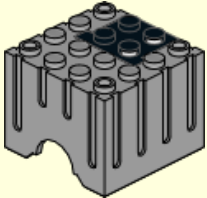








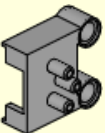
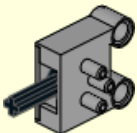
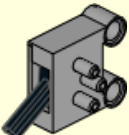
image	file	description
	47154.dat	~Electric Technic Motor 9V Geared (480 RPM) Base
	47154c01.dat	Electric Technic Motor 9v Geared (480RPM) (Complete)
	47155.dat	~Electric Technic Motor 9V Geared (480 RPM) Top
	47156.dat	~Electric Technic Motor 9V Geared (480 RPM) Shaft
	47157.dat	~Electric Technic Motor 9v Geared (480 RPM) Axle Bush
	4716.dat	Technic Worm Gear
	4716b.dat	~Moved to s\4716s01
	4719.dat	Minifig Bicycle Frame (needs work)
	471p01.dat	~Moved to 30127p01
	472.dat	~Moved to 30126
	4720.dat	Wheel Minifig Bicycle
	47222.dat	~Technic Pneumatic Valve with Pegholes Casing
	47223a.dat	Technic Pneumatic Valve with Pegholes (Complete - Neutral Pos.)
	47223b.dat	Technic Pneumatic Valve with Pegholes (Complete - Down Position)

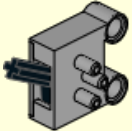
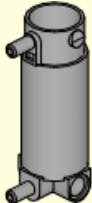





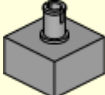

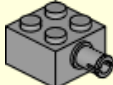

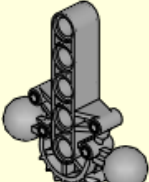
image	file	description
	47223c.dat	Technic Pneumatic Valve with Pegholes (Complete - Up Position)
	47224.dat	~Technic Pneumatic Cylinder 2 x 2 x 5 with Curved Base
	47224c01.dat	Technic Pneumatic Cylinder 2 x 2 x 5 w/ Curved Base (Retracted)
	47224c02.dat	Technic Pneumatic Cylinder 2 x 2 x 5 with Curved Base (Extended)
	47261a.dat	Sticker 2.9 x 2.9 Round with Axlehole Black and White
	4727.dat	Plant Flower 2 x 2 Leaves
	4728.dat	Plant Flower 2 x 2
	4729.dat	Brick 2 x 2 no Studs with Pin Vertical
	472p01.dat	~Moved to 30126p01
	4730.dat	Brick 2 x 2 with Pin
	47300.dat	Technic Bionicle Leg 3 x 3 with 2 Ball Joints
	47306.dat	Technic Bionicle Hip Joint with Beam 5

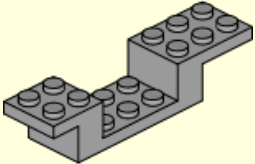

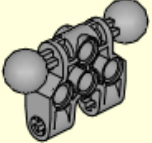



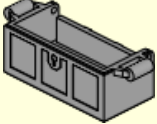
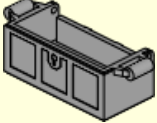
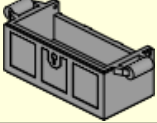
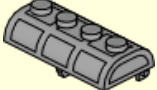
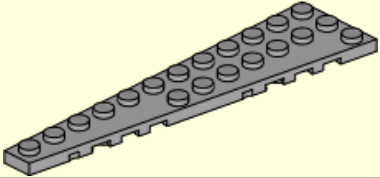
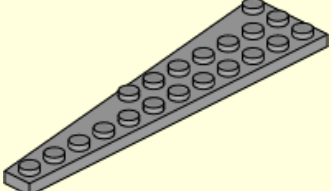
image	file	description
	4732.dat	Bracket 8 x 2 x 1 & 1/3
	4733.dat	Brick 1 x 1 with Studs on Four Sides
	47330.dat	Technic Connector Block 3 x 3 x 1 with Two Ball Joints
	4735.dat	Brick 1 x 1 x 2/3 Round with Bar and Clip Vertical
	4736.dat	Minifig Jet-Pack with Stud On Front
	4737.dat	Space Window 4 x 4 x 6 Outward Sloping Corner
	4738.dat	~Moved to 4738a
	4738a.dat	Container Treasure Chest with Slots
	4738b.dat	Container Treasure Chest without Slots
	4739.dat	Container Treasure Chest Lid
	47397.dat	Wing 3 x 12 Left
	47398.dat	Wing 3 x 12 Right


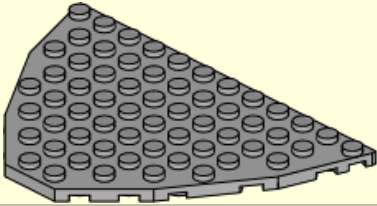
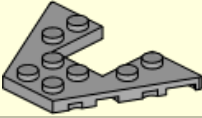
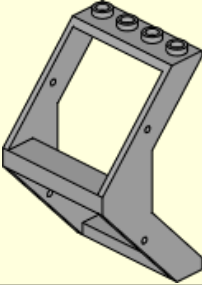

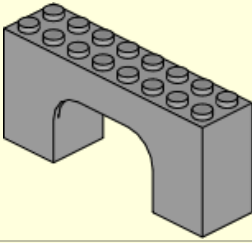
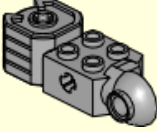
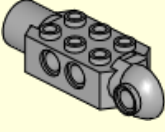
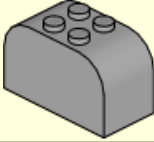
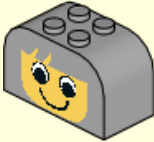

image	file	description
	4740.dat	Dish 2 x 2 Inverted
	47405.dat	Boat Bow Plate 12 x 8
	47407.dat	Wing 4 x 6 with 2 x 2 Cutout
	4741.dat	Window 4 x 4 x 6 Outward Sloping
	4742.dat	Cone 4 x 4 x 2 Hollow No Studs
	4743.dat	Arch 2 x 8 x 3
	47431.dat	Technic Brick 2 x 2 w/ Axlehole, Click Rot. Hinge (V) and Fist
	47432.dat	Technic Brick 2 x 3 w/ Holes, Click Rot. Hinge (V) and Socket
	4744.dat	Brick 2 x 4 x 2 with Curved Top
	4744p01.dat	Brick 2 x 4 x 2 with Curved Top with Plain Face Pattern
	4744p02.dat	Brick 2 x 4 x 2 with Curved Top with Freckled Face Pattern


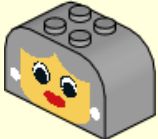
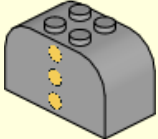

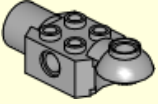
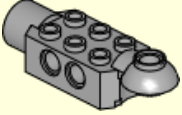




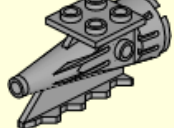
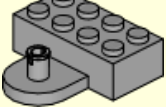

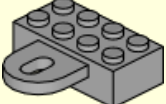
image	file	description
	4744p03.dat	Brick 2 x 4 x 2 with Curved Top with Face/Moustache Pattern
	4744p04.dat	Brick 2 x 4 x 2 with Curved Top with Face/Earrings Pattern
	4744p05.dat	Brick 2 x 4 x 2 with Curved Top with 3 Yellow Dots Pattern
	4745.dat	Propellor 2 Blade 5.5 Diameter
	47452.dat	Technic Brick 2 x 2 w/ Hole, Click Rot. Hinge (H) and Socket
	47454.dat	Technic Brick 2 x 3 w/ Holes, Click Rot. Hinge (H) and Socket
	47455.dat	Technic Pin with Friction with Click Rotation Pin
	47456.dat	Slope Brick Curved 2 x 2 x 2/3 with Fin and 2 Studs
	47457.dat	Slope Brick Curved 2 x 2 x 2/3 Triple with Two Top Studs
	47458.dat	Slope Brick Curved 1 x 2 x 2/3 with Fin without Studs
	4746.dat	Tail 4 x 2 x 2 with Rocket
	4747.dat	Brick 2 x 4 with Coupling, Male
	47474.dat	Plate 2 x 2 with One Stud and Angled Axle
	4748.dat	Brick 2 x 4 with Coupling, Female

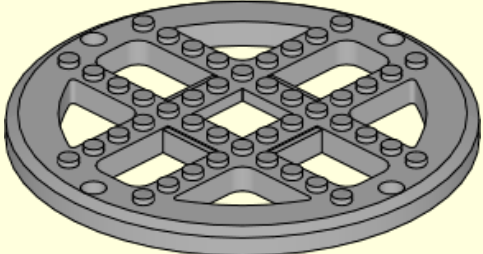

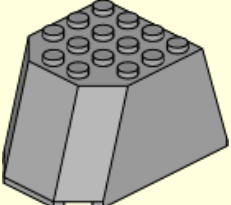
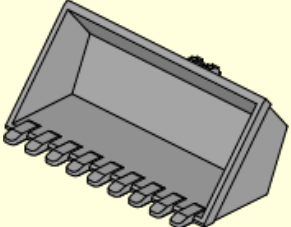
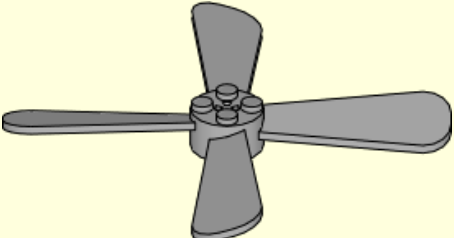
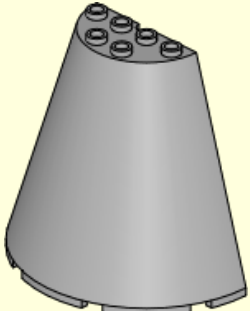

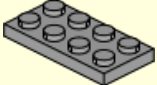
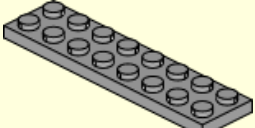
image	file	description
	4750.dat	Brick Round 13.667 x 13.667 Fabuland Hollowed
	47501.dat	Technic Connector 1 x 2 with Two Pins and Stepped Wedge
	47506.dat	Windscreen 6 x 4 x 3
	47508.dat	Excavator Bucket 8 x 4 with Click Hinge 2-Finger
	4751.dat	Propellor 4 Blade 13 Diameter
	47543.dat	Cone 8 x 4 x 6 Half
	4755.dat	Electric Plate 1 x 2 with Contacts
	4757.dat	Electric Plate 2 x 4 with Contacts
	4758.dat	Electric Plate 2 x 8 with Contacts

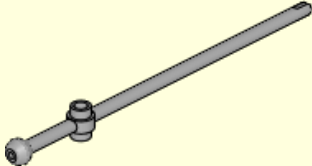
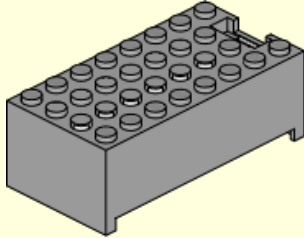
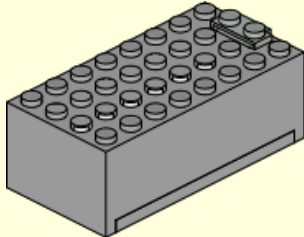
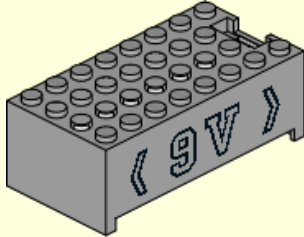
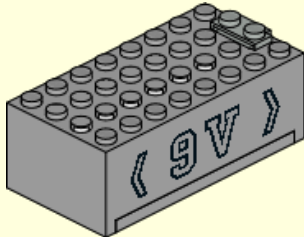
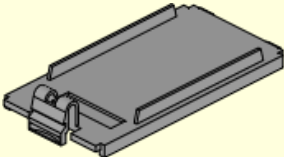


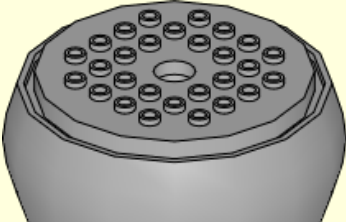
image	file	description
	476.dat	Bar 12L with Hollow Studs, Towball, and Slit
	4760.dat	~Electric 9V Battery Box 4 x 8 x 2.333 Cover
	4760c01.dat	Electric 9V Battery Box 4 x 8 x 2.333 (Complete)
	4760p01.dat	~Electric 9V Battery Box 4 x 8 x 2.333 Cover w/ "9V" Pattern
	4760p01c01.dat	Electric 9V Battery Box 4 x 8 x 2.333 "9V" Patt. (Complete)
	4761.dat	Electric 9V Battery Box 4 x 8 x 2 1/3 Lid
	4762.dat	~Electric 9V Battery Box 4 x 8 x 2.333 Switch
	4767.dat	Electric Light & Sound Brick 1 x 2 with Single Top Light
	47674.dat	Container Storage X-Pod Middle (Needs Work)


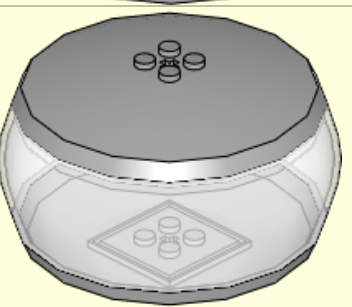
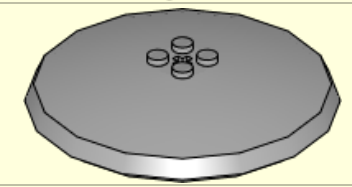
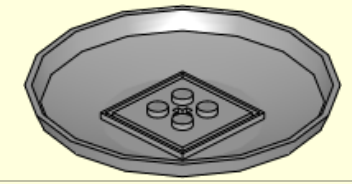


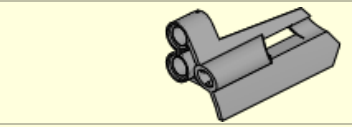


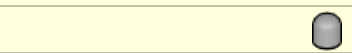
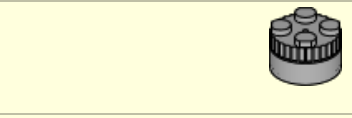

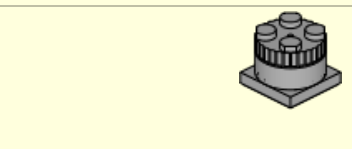
image	file	description
		
	47674c01.dat	Container Storage X-Pod (Complete, Clear Middle)
	47675.dat	Container Storage X-Pod Top (Needs Work)
	47676.dat	Container Storage X-Pod Base (Needs Work)
	4770.dat	Electric Light & Sound Colored Globe
	4771.dat	Electric Light & Sound Brick 1 x 4 with Twin Top Lights
	47712.dat	Technic Panel Fairing #24
	47713.dat	Technic Panel Fairing #25
	47720.dat	Plate 2 x 2 with Wishbone Suspension Arms and Pins
	4773.dat	~Moved to 4770
	4773a.dat	~Electric Light & Sound Brick 2 x 2 x 1.333 Siren Top
	4774.dat	~Electric Light & Sound Brick 2 x 2 x 1.333 Siren Base
	4774c01.dat	Electric Light & Sound Brick 2 x 2 x 1.333 Siren (Complete)

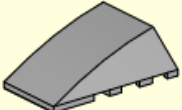
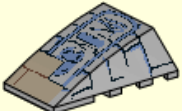
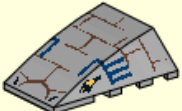
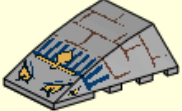
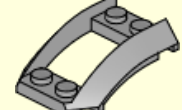
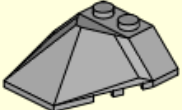
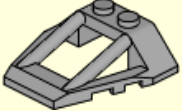
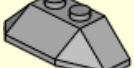
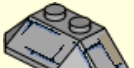
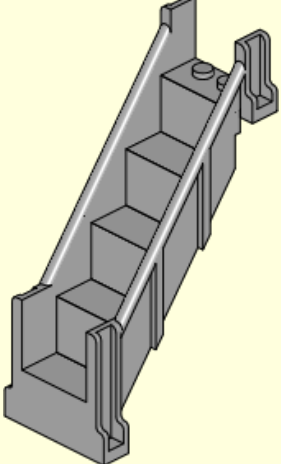
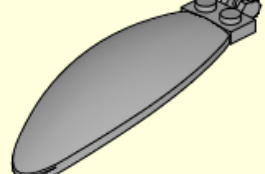
image	file	description
	47753.dat	Wedge 4 x 4 Triple Curved without Studs
	47753pq1.dat	Wedge 4 x 4 Triple Curved with Brick and Hieroglyphs Pattern
	47753pq2.dat	Wedge 4 x 4 Triple Curved with Bricks and 2 Eyes Pattern
	47753pq3.dat	Wedge 4 x 4 Triple Curved with Bricks and 4 Eyes Pattern
	47755.dat	Wedge 4 x 3 Curved with 2 x 2 Cutout
	47757.dat	Wedge 4 x 4 Quadruple Convex Slope Center
	47758.dat	Windscreen 4 x 4 x 1 Roll Cage
	47759.dat	Wedge 2 x 4 Triple
	47759pq1.dat	Wedge 2 x 4 Triple with Brick Pattern
	4784.dat	Staircase 4 x 6 x 7 1/3 Enclosed Straight
	47844.dat	Windscreen 9 x 3 x 1.667 Bubble Canopy

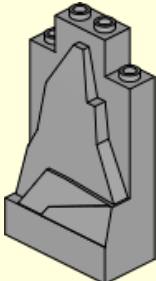





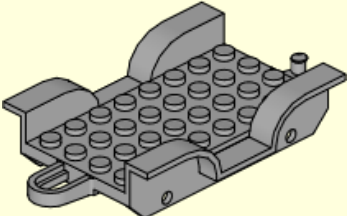
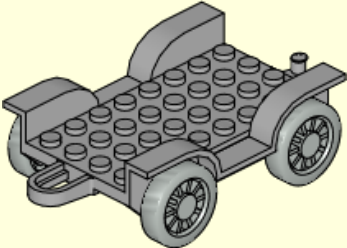
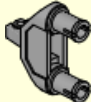
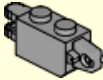
image	file	description
	47847.dat	Panel 2 x 4 x 6 Rock
	4790.dat	Boat Ship Wheel
	47905.dat	Brick 1 x 1 with Studs on Two Opposite Sides
	4791.dat	Fabuland Sailor's Cap
	4792.dat	Fabuland Captain's Cap
	4794b.dat	Fabuland Oar with Bar Handle
	4796.dat	Fabuland Car Chassis 8 x 6
	4796c01.dat	Fabuland Car Chassis 8 x 6.5 (Complete)
	47973.dat	Technic Connector 3 x 1 x 3 with Two Pins and Click Hinge
	47975.dat	Hinge Brick 1 x 2 Locking with Dual Finger Horiz. Single Vert.


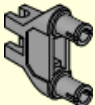
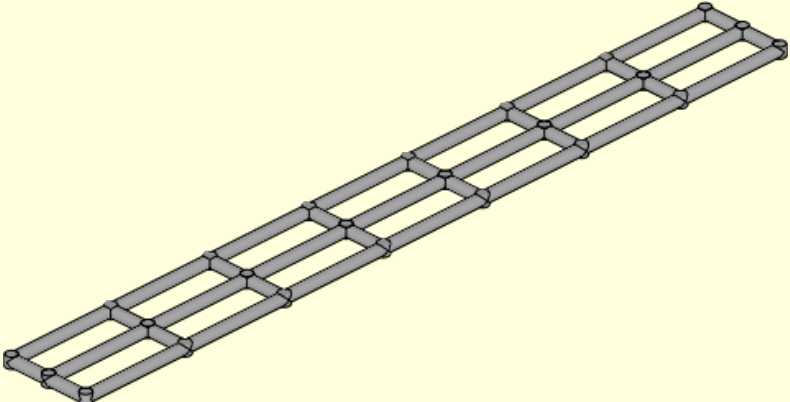
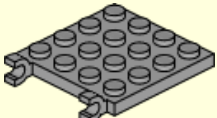


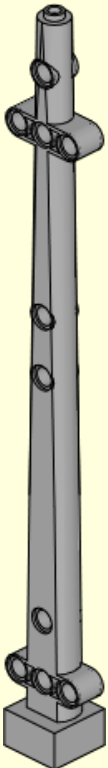
image	file	description
	47990.dat	Brick 4 x 3 x 1 with Skull Relief and Two Pins
	47994.dat	Technic Connector 3 x 1 x 3 with Two Pins and Two Clips
	47996.dat	Boat Rigging 4 x 28 Rectangular
	47998.dat	Plate 4 x 4 with 2 Clips Horizontal
	48.dat	~Moved to 3049
	480.dat	~Moved to 30554
	48002.dat	Boat Mast 3 x 2 x 20



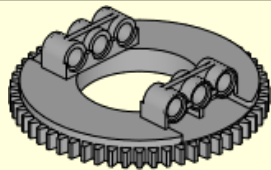
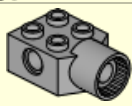


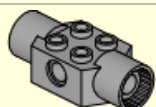
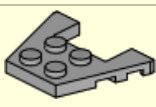

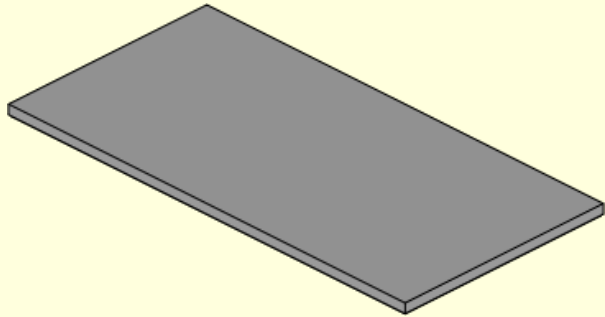
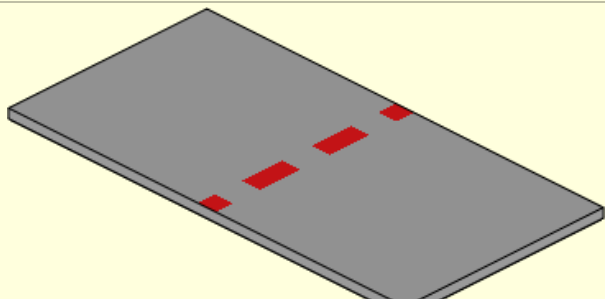
image	file	description
	48092.dat	Brick 4 x 4 Round Corner
	481.dat	Hinge Arm Locking with Single Finger and Axlehole
	48168.dat	Technic Turntable Type 2 Top
	48169.dat	Technic Brick 2 x 2 with Hole and Rotation Joint Socket
	48170.dat	Technic Brick 2 x 2 with Hole, Half Rotation Joint Ball Horiz
	48171.dat	Technic Brick 2 x 2 with Hole, Half Rotation Joint Ball Vert
	48172.dat	Technic Brick 2 x 2 with Hole and Two Rotation Joint Sockets
	48183.dat	Wing 3 x 4 with 1 x 2 Cutout with Stud Notches
	482.dat	Hinge Arm Locking with Dual Finger and Axlehole
	48288.dat	Tile 8 x 16
	48288p01.dat	Tile 8 x 16 with Red Dashes Pattern

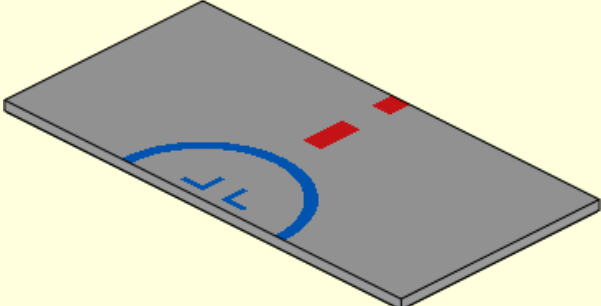
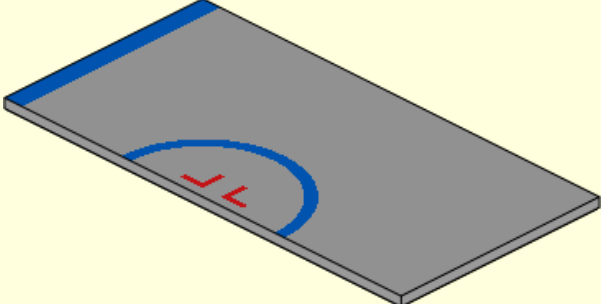
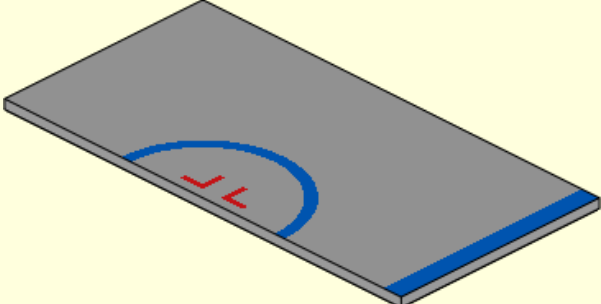

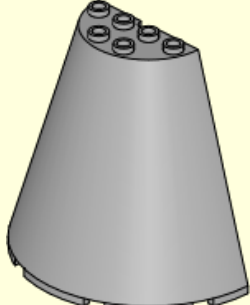

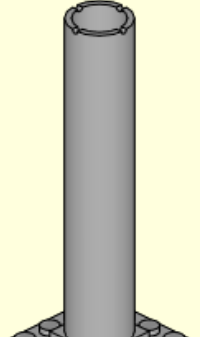
image	file	description
	48288p02.dat	Tile 8 x 16 with Blue Semicircle and Red Dashes Pattern
	48288p03.dat	Tile 8 x 16 with Blue Semicircle and Stripe on Left Pattern
	48288p04.dat	Tile 8 x 16 with Blue Semicircle and Stripe on Right Pattern
	483.dat	~Moved to 41532
	48310.dat	Cone 8 x 4 x 6 Half
	48336.dat	Plate 1 x 2 with Handle Type 2
	4844.dat	Boat Mast Base 4 x 4 x 9

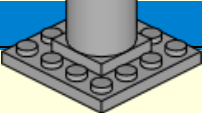
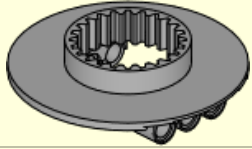

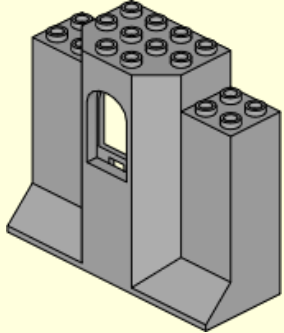


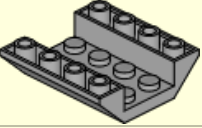
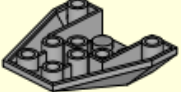
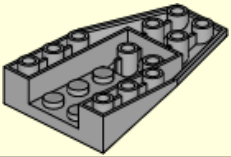
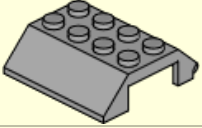
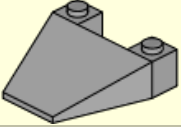
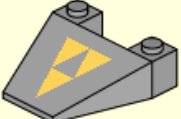
image	file	description
		
	48452.dat	Technic Turntable Type 2 Base
	48457.dat	Bar 2L with Two Clips and Bottom Stud
	48490.dat	Panel Wall 3 x 8 x 6
	48494.dat	Minifig Shield Octagonal with Stud
	48496.dat	Technic Connector Toggle Joint Smooth Double with 2 Pins
	4854.dat	Slope Brick 45 4 x 4 Double Inverted with Open Center
	4855.dat	Wedge 4 x 4 Triple Inverted
	4856.dat	Wedge 6 x 4 Inverted
	4857.dat	Slope Brick 45 4 x 4 Double with Hinge
	4858.dat	Wedge 4 x 4
	4858p01.dat	Wedge 4 x 4 with Blacktron I Logo

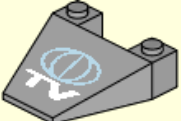
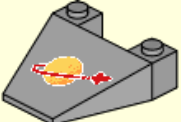
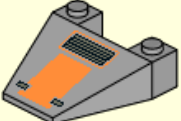
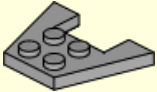

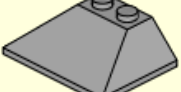

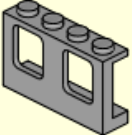
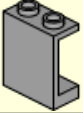
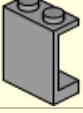





image	file	description
	4858p1k.dat	Wedge 4 x 4 with TV Logo Pattern
	4858p90.dat	Wedge 4 x 4 with Classic Space Pattern
	4858px4.dat	Wedge 4 x 4 with SW Orange Rectangle and Vent Pattern
	4859.dat	Wing 3 x 4 with 1 x 2 Cutout without Stud Notches
	4860.dat	~Moved to 4870
	4861.dat	Slope Brick 45 3 x 4 Double / 33
	4862.dat	Glass for Window 1 x 2 x 2 Plane
	4863.dat	Window 1 x 4 x 2 Plane
	4864.dat	~Moved to 4864b
	4864a.dat	Panel 1 x 2 x 2 with Solid Studs
	4864ap01.dat	Panel 1 x 2 x 2 with Autoroute Pattern
	4864ap02.dat	Panel 1 x 2 x 2 with Red Cross Pattern
	4864ap03.dat	Panel 1 x 2 x 2 with Utility Pattern
	4864ap10.dat	Panel 1 x 2 x 2 Solid Stud with Red/White/Blue Left Pattern
	4864ap11.dat	Panel 1 x 2 x 2 Solid Stud with


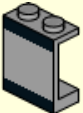
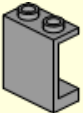


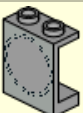
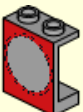

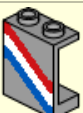
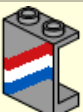

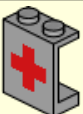



image		file	description
			Red/White/Blue Right Pattern
		4864ap12.dat	Panel 1 x 2 x 2 with Black Stripes Pattern
		4864b.dat	Panel 1 x 2 x 2 with Hollow Studs
		4864bp10.dat	Panel 1 x 2 x 2 Hollow Stud with Red/White/Blue Left Pattern
		4864bp11.dat	Panel 1 x 2 x 2 Hollow Stud with Red/White/Blue Right Pattern
		4864bp12.dat	Panel 1 x 2 x 2 with Grey Porthole Pattern
		4864bp13.dat	Panel 1 x 2 x 2 with Red Porthole Pattern
		4864bp71.dat	Panel 1 x 2 x 2 with Phone in White Circle and Lines Patt.
		4864p33.dat	~Moved to 4864bp10
		4864p34.dat	~Moved to 4864bp11
		4864p35.dat	~Moved to 4864ap01
		4864p66.dat	~Moved to 4864ap02
		4864p89.dat	~Moved to 4864ap03
		4865.dat	~Moved to 4865a
		4865a.dat	Panel 1 x 2 x 1 with Square Corners






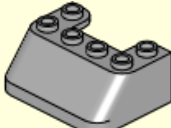
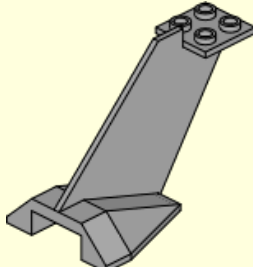

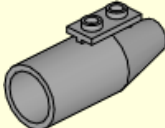
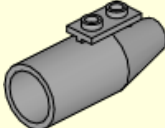


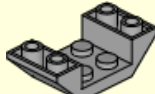
image	file	description
	4865b.dat	Panel 1 x 2 x 1 with Rounded Corners
	4865p01.dat	Panel 1 x 2 x 1 with Train Logo Black Pattern
	4865p02.dat	Panel 1 x 2 x 1 with Train Logo White Pattern
	4865p06.dat	Panel 1 x 2 x 1 with Black Grille Pattern
	4865p18.dat	Panel 1 x 2 x 1 with Thin Black "POLICE" Pattern
	4866.dat	Windscreen 3 x 4 x 1 & 1/3 with 6 Studs on Top
	4867.dat	Tail Plane
	4867p10.dat	Wedge 4 x 4 with Tail Plane with Red/Black Pattern
	4868.dat	Plane Jet Engine
	4868a.dat	Plane Jet Engine
	4869.dat	Plane Jet Engine Centre
	4870.dat	Plate 2 x 2 with Wheels Holder Plane
	4871.dat	Slope Brick 45 4 x 2 Double Inverted with Open Center

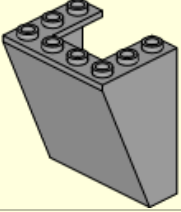




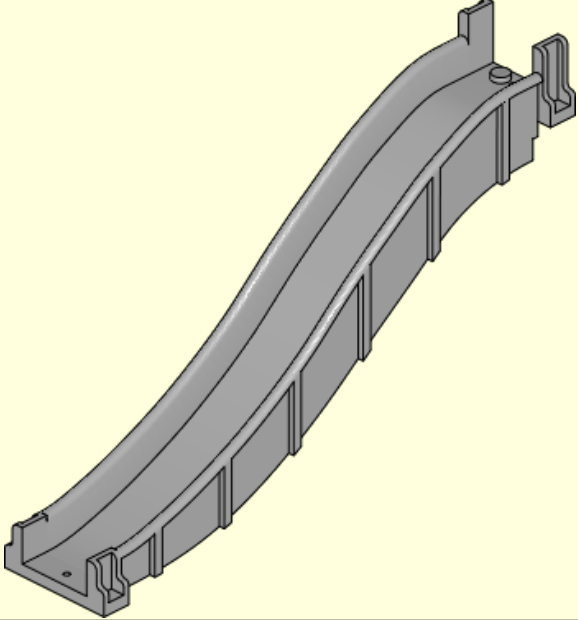

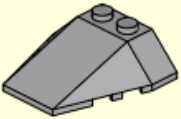
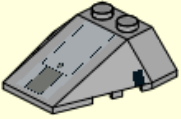
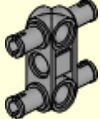

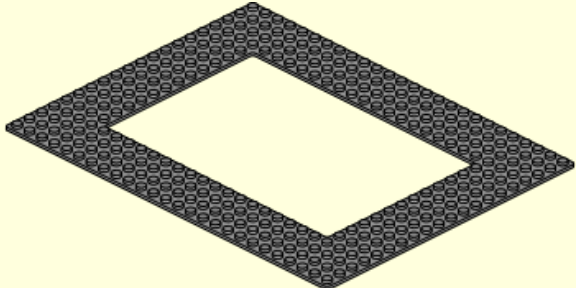
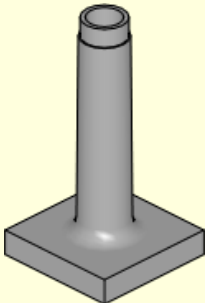




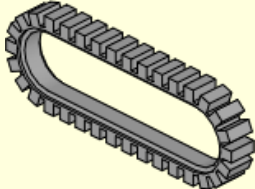


image	file	description
	4872.dat	Windscreen 3 x 4 x 4 Inverted
	48723.dat	Bar 1L Quadruple with Axlehole Hub
	48724.dat	Bracket 1 x 1 - 1 x 1 with Pin
	48729.dat	Bar 1.5L with Clip
	4873.dat	Bar 1 x 6 with Studs Open
	4876.dat	Fabuland Slide
	48812.dat	Animal Wolf
	48933.dat	Wedge 4 x 4 Triple with Stud Notches
	48933ps1.dat	Wedge 4 x 4 Triple with Stud Notches & Grey Mechanical Pattern
	48989.dat	Technic Cross Block 1 x 3 (Pin/Pin/Pin) with 4 Pins
	48995.dat	Tile 2 x 3 Rounded with Hole

image	file	description
	49059.dat	Baseplate 20 x 26 with 12 x 18 Hole
	4913.dat	Duplo Sign Post Tall
	49668.dat	Plate 1 x 1 with Tooth
	49673.dat	Plate 1 x 1 with Tooth
	497.dat	~Moved to 7039
	497a.dat	~Wheel Old with 4 Studs
	498.dat	Technic Tread Crawler
	499.dat	~Magnet Cylindrical Casing for Plate 2 x 4
	499c01.dat	Magnet Cylindrical in Casing for Plate 2 x 4 (Complete)